

WALL MOUNT SPEAKERS

BS-633A BS-633AT

Thank you for purchasing TOA's Wall Mount Speaker. Please carefully follow the instructions in this manual to ensure long, trouble-free use of your equipment.

1. SAFETY PRECAUTIONS

- Before installation or use, be sure to carefully read all the instructions in this section for correct and safe operation.
- Be sure to follow all the precautionary instructions in this section, which contain important warnings and/or cautions regarding safety.
- After reading, keep this manual handy for future reference.

WARNING

Indicates a potentially hazardous situation which, if mishandled, could result in death or serious personal injury.

- Install the unit only in a location that can structurally support the weight of the unit and the mounting bracket. Doing otherwise may result in the speaker falling down and causing personal injury and/or property damage.

CAUTION

Indicates a potentially hazardous situation which, if mishandled, could result in moderate or minor personal injury, and/or property damage.

- Do not operate the speaker for an extended period of time with the sound distorting. This is an indication of a malfunction, which in turn can cause heat to generate and result in a fire.
- Do not stand or sit on, nor hang down from the speaker as this may cause it to fall down or drop, resulting in personal injury and/or property damage.

Traceability Information for Europe (EMC directive 2004/108/EC)

Manufacturer:
TOA Corporation
7-2-1, Minatojima Nakamachi, Chuo-ku, Kobe, Hyogo, Japan

Authorized representative:
TOA Electronics Europe GmbH
Suederstrasse 282, 20537 Hamburg, Germany

2. GENERAL DESCRIPTION

The BS-633A and BS-633AT are wall mount speakers made of ABS resin and can be hooked or mounted directly on the wall.

The push-in type input terminal makes cable connections easy and allows bridge wiring. The input impedance can be easily changed by changing the tap position of the transformer from the rear side of the speaker.

Besides the above features, the BS-633AT has a built-in attenuator and can be connected to a 2-wire and 3-wire systems.

3. INSTALLATION

3.1. Wall Mounting by Hooking the Speaker onto Screws

Step 1. Mount the 2 supplied wood screws to the wall 120 mm (4.73") apart, leaving the heads projecting 8 – 10 mm (0.31" – 0.39") from the wall surface.

Step 2. Connect the speaker cable to the speaker's push-in terminal block.

Note: Bridge wiring can also be performed. For more information on connection procedures, refer to the section "CONNECTIONS."

Step 3. Using the distance markers provided on the top of the speaker, align the mounting holes in the rear panel of the speaker with the protruding screws, and hang the speaker on the wall.

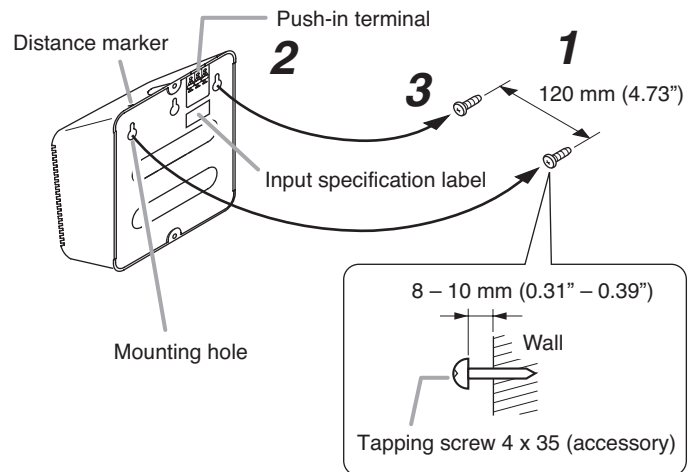

3.2. Wall Mounting by Directly Screwing the Speaker

Step 1. Connect the speaker cable to the push-in terminal block.

Note: Bridge wiring can also be performed. For more information on connection procedures, refer to the section "CONNECTIONS."

Step 2. Using the 2 supplied tapping screws, fix the speaker to the wall.

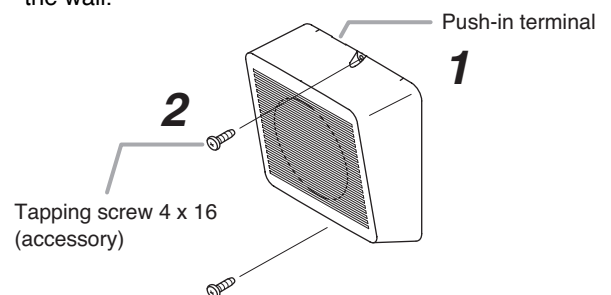

4. CONNECTIONS

Use the following cables for connections.

- Solid wire: $\phi 0.8$ to $\phi 1.6$ mm (equivalent to AWG 20 – 14)
- Stranded wire (7-core): 0.75 to 1.25 mm² (equivalent to AWG 18 – 16)

Step 1. Using the cable strip gauge printed on the input specification label, trim cable sheath 9 mm (0.35") from cable end.

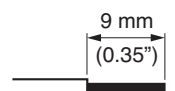

Step 2. Insert the cable fully into the round hole in the terminal block.

Step 3. To remove the cable, pull it out while pressing the terminal block button.

5. WIRING

To change impedance, change the tap position of the transformer.

5.1. BS-633A (without an Attenuator)

[Wiring diagram]

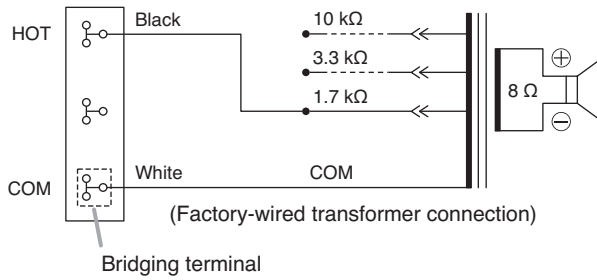

5.2. BS-633AT (with an Attenuator)

[2-wire system connection]

Note: Short the COM terminal with the R terminal.

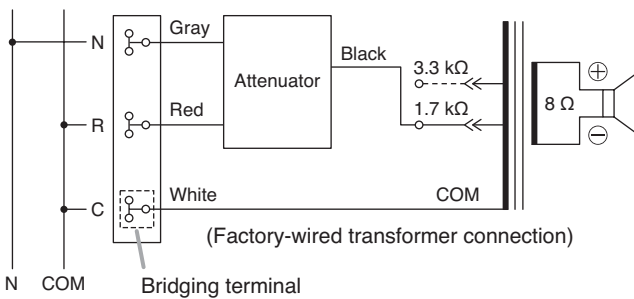

[3-wire system connection]

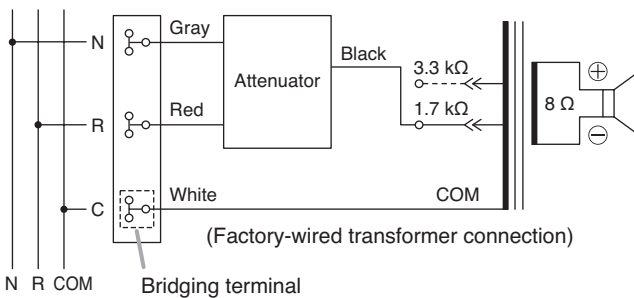

6. INPUT CHANGE

The BS-633A/633AT's input is factory-preset to 1.7 kΩ.

To change this, detach the black wire connector from the 1.7 kΩ terminal, and reconnect it to the 3.3 kΩ or 10 kΩ terminal for the BS-633A, or the 3.3 kΩ terminal for the BS-633AT.

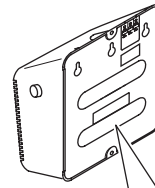

• BS-633A

To change the factory presetting (1.7 kΩ), detach and reconnect the black wire to the 3.3 kΩ or 10 kΩ terminal.

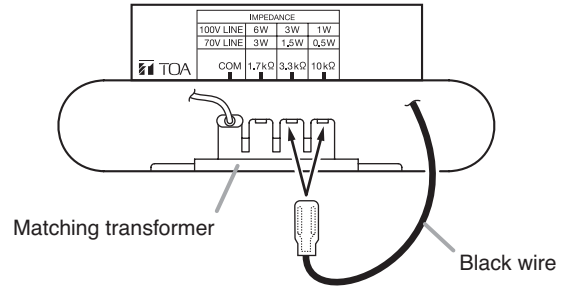

• BS-633AT

To change the factory presetting (1.7 kΩ), detach and reconnect the black wire to the 3.3 kΩ terminal.

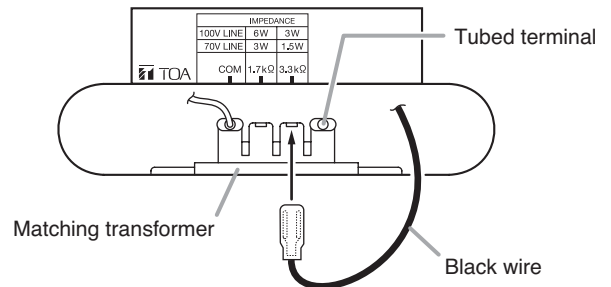

Caution

Never connect the black wire to the rightmost tubed terminal. Failure to observe this instruction may cause the amplifier overload at an attenuator position, resulting in system failure.

7. SPECIFICATIONS

Model No.	BS-633A	BS-633AT
Rated Input	6 W (100 V line), 3 W (70 V line)	
Rated Impedance	100 V line: 1.7 kΩ (6 W), 3.3 kΩ (3 W), 10 kΩ (1 W) 70 V line: 1.7 kΩ (3 W), 3.3 kΩ (1.5 W), 10 kΩ (0.5 W)	100 V line: 1.7 kΩ (6 W), 3.3 kΩ (3 W) 70 V line: 1.7 kΩ (3 W), 3.3 kΩ (1.5 W)
Sensitivity	91 dB at 1 W, 1 m (500 – 5,000 Hz, pink noise)	
Frequency Response	120 – 15,000 Hz (at 20 dB below peak)	
Speaker Component	12 cm (5") cone-type	
Usable Cable	600 V vinyl-insulated cable (IV wire or HIV wire), Solid wire: $\phi 0.8$ – $\phi 1.6$ mm (equivalent to AWG 20 – 14), 7-core twisted wire: 0.75 – 1.25 mm ² (equivalent to AWG 18 – 16)	
Connection	Push-in connector (bridging terminal)	
Attenuation Level	—	3 W: OFF, 1 (–12 dB), 2 (–6 dB), 3 (0 dB) 6 W: OFF, 1 (–13 dB), 2 (–7 dB), 3 (0 dB)
Operating Temperature	–10°C to +50°C (14°F to 122°F)	
Finish	Case: ABS resin, off white, Rear board: hard board	
Dimensions	173 (w) x 195 (h) x 101 (d) mm or 6.81" x 7.68" x 3.98" (excluding the attenuator in the case of BS-633AT)	
Wall Mounting Dimensions	Front fixing hole spacing: 184 mm (7.24"), Rear hook hole spacing: 120 mm (4.73")	
Weight	780 g (1.72 lb)	810 g (1.79 lb)
Accessories	Tapping screw 4 x 16 2, Tapping screw 4 x 35 2	

Note: The design and specifications are subject to change without notice for improvement.