

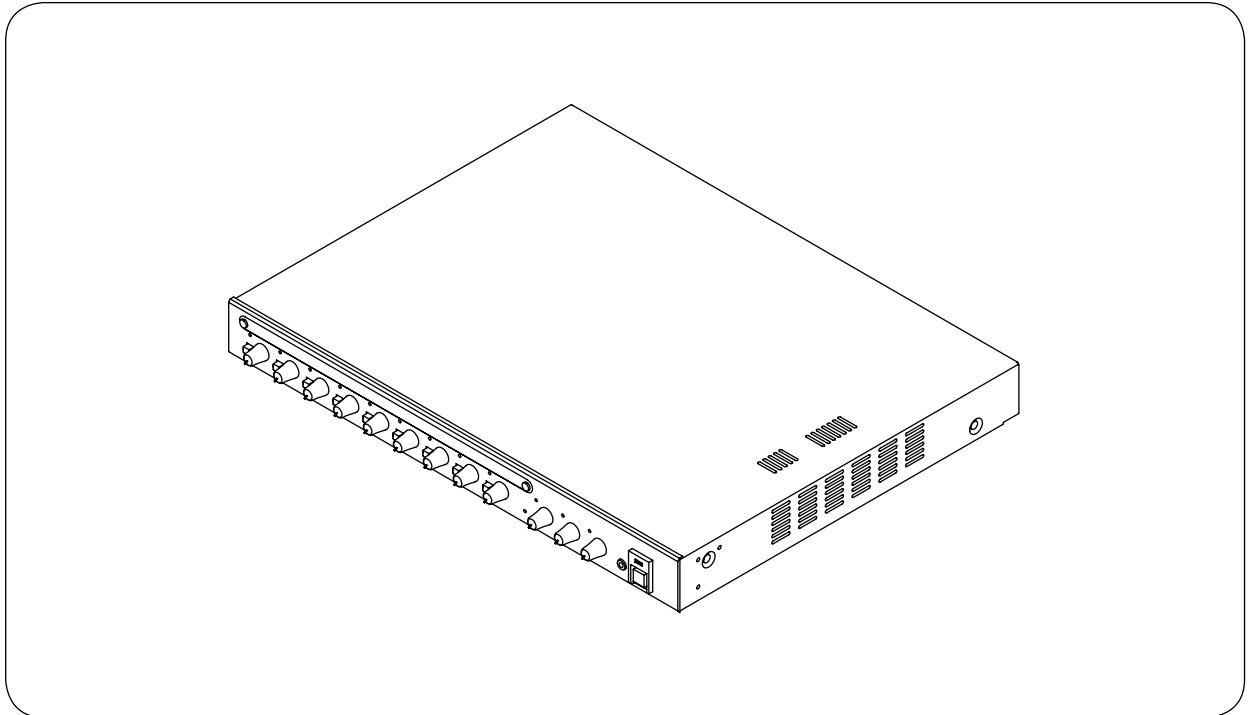

OPERATING INSTRUCTIONS

DIGITAL STEREO MIXER

M-633D



Thank you for purchasing TOA's Digital Stereo Mixer.
Please carefully follow the instructions in this manual to ensure long, trouble-free use of your equipment.

TABLE OF CONTENTS

1. IMPORTANT SAFETY INSTRUCTIONS	3
2. SAFETY PRECAUTIONS	4
3. GENERAL DESCRIPTION	6
4. FEATURES	6
5. HANDLING PRECAUTIONS	6
6. NOMENCLATURE AND FUNCTIONS	7
Front	7
Rear	8
7. ASSIGNMENT SETTINGS	9
8. USING THE SUMMING OUTPUT KEYS	10
9. SETTING THE ARC FUNCTION	11
9.1. What is the Automatic Resonance Control (ARC) Function?	11
9.2. Outline of the ARC Function Settings	11
9.3. Enabling the ARC Function	13
9.4. Making Fine Acoustic Adjustment	19
9.5. Disabling the ARC Function	20
10. SETTING THE FBS FUNCTION	21
10.1. What is the Feedback Suppressor Function (FBS)?	21
10.2. Setting the FBS Function	21
11. SETTING THE AUTOMATIC MUTE FUNCTION	22
11.1. What is the Automatic Mute Function (AUTO MUTE)?	22
11.2. Setting the Automatic Mute Function	22
12. AUTOMATIC CLIPGUARD (ACG) FUNCTION	23
13. RESETTING TO FACTORY DEFAULT SETTINGS	24
14. INSTALLATION	24
14.1. Mounting in a Rack	24
14.2. Mounting on a Desk	25
15. CONNECTION	26
15.1. Connection Example	26
15.2. Phantom Power Supply	26
15.3. Removable Terminal Plug Connection	27
16. BLOCK DIAGRAM	28
17. DIMENSIONAL DIAGRAM	30
18. SPECIFICATIONS	31
Accessories	32

1. IMPORTANT SAFETY INSTRUCTIONS

- Read these instructions.
- Keep these instructions.
- Heed all warnings.
- Follow all instructions.
- Do not use this apparatus near water.
- Clean only with dry cloth.
- Do not block any ventilation openings. Install in accordance with the manufacturer's instructions.
- Do not install near any heat sources such as radiators, heat registers, stoves, or other apparatus (including amplifiers) that produce heat.
- Do not defeat the safety purpose of the polarized or grounding-type plug. A polarized plug has two blades with one wider than the other. A grounding type plug has two blades and a third grounding prong. The wide blade or the third prong are provided for your safety. If the provided plug does not fit into your outlet, consult an electrician for replacement of the obsolete outlet.
- Protect the power cord from being walked on or pinched particularly at plugs, convenience receptacles, and the point where they exit from the apparatus.
- Only use attachments/accessories specified by the manufacturer.
- Use only with the cart, stand, tripod, bracket, or table specified by the manufacturer, or sold with the apparatus. When a cart is used, use caution when moving the cart/apparatus combination to avoid injury from tip-over.
- Unplug this apparatus during lightning storms or when unused for long periods of time.
- Refer all servicing to qualified service personnel. Servicing is required when the apparatus has been damaged in any way, such as power-supply cord or plug is damaged, liquid has been spilled or objects have fallen into the apparatus, the apparatus has been exposed to rain or moisture, does not operate normally, or has been dropped.



INSTRUCTIONS ESSENTIELLES POUR LA SÉCURITÉ

- Lire ces instructions.
- Conserver ces instructions pour référence ultérieure.
- Respecter tous les avertissements.
- Suivre toutes les instructions.
- Ne pas utiliser cet appareil à proximité d'eau.
- Nettoyer uniquement à l'aide d'un chiffon sec.
- Ne pas obstruer les orifices de ventilation. Installer conformément aux instructions du fabricant.
- Ne pas installer à proximité de sources de chaleur telles que des radiateurs, des registres thermiques, des chaudières ou d'autres appareils (notamment des amplificateurs) produisant de la chaleur.
- Ne pas contourner la fonction de sécurité de la fiche polarisée ou de mise à la terre. Une fiche polarisée est équipée de deux broches, dont l'une est plus large que l'autre. Une fiche de mise à la terre est équipée de deux broches et d'une troisième pour la mise à la terre. Cette dernière, la plus large, est prévue à des fins de sécurité. Si la fiche fournie ne peut être insérée dans la prise électrique souhaitée, consulter un électricien pour faire remplacer cette dernière.
- Protéger le cordon d'alimentation pour éviter qu'il ne soit piétiné ou pincé, notamment au niveau des fiches, des prises de courant ou de son point de sortie de l'appareil.
- Utiliser uniquement les accessoires spécifiés par le fabricant.
- Utiliser uniquement avec le chariot, support, trépied, la patte de montage ou la table spécifiés par le fabricant ou vendus avec l'appareil. En cas d'utilisation d'un chariot, manipuler la combinaison chariot/appareil pour éviter les blessures dues à un renversement.
- Débrancher cet appareil pendant les orages ainsi que lorsqu'il reste inutilisé pendant une période prolongée.
- La maintenance de l'appareil doit être confiée à un technicien après-vente qualifié. Une maintenance s'avère nécessaire si l'appareil est endommagé (au niveau du cordon d'alimentation ou de la fiche), a été mouillé par un liquide, un objet est tombé à l'intérieur, s'il a été exposé à la pluie ou l'humidité, s'il ne fonctionne pas normalement ou s'il est tombé.





2. SAFETY PRECAUTIONS

- Before installation or use, be sure to carefully read all the instructions in this section for correct and safe operation.
- Be sure to follow all the precautionary instructions in this section, which contain important warnings and/or cautions regarding safety.
- After reading, keep this manual handy for future reference.

Safety Symbol and Message Conventions

Safety symbols and messages described below are used in this manual to prevent bodily injury and property damage which could result from mishandling. Before operating your product, read this manual first and understand the safety symbols and messages so you are thoroughly aware of the potential safety hazards.

 **WARNING** Indicates a potentially hazardous situation which, if mishandled, could result in death or serious personal injury.

 **CAUTION** Indicates a potentially hazardous situation which, if mishandled, could result in moderate or minor personal injury, and/or property damage.

 **WARNING**
 **AVERTISSEMENT**

When Installing the Unit Lors de l'installation de l'appareil

- Do not expose the unit to rain or an environment where it may be splashed by water or other liquids, as doing so may result in fire or electric shock.
- Ne pas exposer l'appareil à la pluie et le protéger de tout contact avec de l'eau ou d'autres liquides afin d'éviter un incendie ou une électrocution.
- Use the unit only with the voltage specified on the unit. Using a voltage higher than that which is specified may result in fire or electric shock.
- Do not cut, kink, otherwise damage nor modify the power supply cord. In addition, avoid using the power cord in close proximity to heaters, and never place heavy objects -- including the unit itself -- on the power cord, as doing so may result in fire or electric shock.
- Avoid installing or mounting the unit in unstable locations, such as on a rickety table or a slanted surface. Doing so may result in the unit falling down and causing personal injury and/or property damage.
- Since the unit is designed for in-door use, do not install it outdoors. If installed outdoors, the aging of parts causes the unit to fall off, resulting in personal injury. Also, when it gets wet with rain, there is a danger of electric shock.

When the Unit is in Use

- Should the following irregularity be found during use, immediately switch off the power, disconnect the power supply plug from the AC outlet and contact your nearest TOA dealer. Make no further attempt to operate the unit in this condition as this may cause fire or electric shock.
- If you detect smoke or a strange smell coming from the unit.
- If water or any metallic object gets into the unit
- If the unit falls, or the unit case breaks
- If the power supply cord is damaged (exposure of the core, disconnection, etc.)
- If it is malfunctioning (no tone sounds.)
- To prevent a fire or electric shock, never open nor remove the unit case as there are high voltage components inside the unit. Refer all servicing to qualified service personnel.
- Do not place cups, bowls, or other containers of liquid or metallic objects on top of the unit. If they accidentally spill into the unit, this may cause a fire or electric shock.
- Do not insert nor drop metallic objects or flammable materials in the ventilation slots of the unit's cover as this may result in fire or electric shock.
- The socket-outlet shall be installed near the equipment and the plug shall be easily accessible.
- The apparatus shall be connected to a main socket outlet with a protective earthing connection.

In Finland:

“Laite on liitettävä suojamaadoituskoskettimilla varustettuun pistorasiaan”

In Norway:

“Apparatet må tilkoples jordet stikkontakt”

In Sweden:

“Apparaten skall anslutas till jordat uttag”

CAUTION

When Installing the Unit

- Never plug in nor remove the power supply plug with wet hands, as doing so may cause electric shock.
- When unplugging the power supply cord, be sure to grasp the power supply plug; never pull on the cord itself. Operating the unit with a damaged power supply cord may cause a fire or electric shock.
- When moving the unit, be sure to remove its power supply cord from the wall outlet. Moving the unit with the power cord connected to the outlet may cause damage to the power cord, resulting in fire or electric shock. When removing the power cord, be sure to hold its plug to pull.
- Do not block the ventilation slots in the unit's cover. Doing so may cause heat to build up inside the unit and result in fire. Also, periodically clean the ventilation slots of dust.
- Avoid installing the unit in humid or dusty locations, in locations exposed to the direct sunlight, near the heaters, or in locations generating sooty smoke or steam as doing otherwise may result in fire or electric shock.
- Be sure to follow the instructions below when rack-mounting the unit. Failure to do so may cause a fire or personal injury.

- Install the equipment rack on a stable, hard floor. Fix it with anchor bolts or take other arrangements to prevent it from falling down.

- When connecting the unit's power cord to an AC outlet, use the AC outlet with current capacity allowable to the unit.

(Every version except the M-633D CU for US)

- The supplied rack-mounting screws can be used for the TOA equipment rack only. Do not use them for other racks.

(M-633D CU for US)

- Rack-mounting screws are not supplied with the unit. Prepare them that are appropriate for the equipment rack.
- Be sure to complete installation and cable connections before connecting the unit's power plug to the power source. When uninstalling the unit or disconnecting the unit's cables, be sure to disconnect the power plug from the power source first. Doing otherwise may result in electrical shock.

When the Unit is in Use

- If dust accumulates on the power supply plug or in the wall AC outlet, a fire may result. Clean it periodically. In addition, insert the plug in the wall outlet securely.
- Switch off the power, and unplug the power supply plug from the AC outlet for safety purposes when cleaning or leaving the unit unused for 10 days or more. Doing otherwise may cause a fire or electric shock.



The lightning flash with arrowhead symbol, within an equilateral triangle, is intended to alert the user to the presence of uninsulated "dangerous voltage" within the product's enclosure that may be of sufficient magnitude to constitute a risk of electric shock to persons.



The exclamation point within an equilateral triangle is intended to alert the user to the presence of important operation and maintenance (servicing) instruction in the literature accompanying the appliance.



L'éclair accompagné d'un symbole représentant une pointe de flèche à l'intérieur d'un triangle équilatéral avertit l'utilisateur de la présence d'une "tension dangereuse" à l'intérieur de l'enceinte du téléviseur, dont la magnitude peut être suffisante pour constituer un risque de choc électrique pour les personnes.



Le point d'exclamation à l'intérieur d'un triangle équilatéral avertit l'utilisateur de l'existence d'instructions d'utilisation et d'entretien (réparation) dans la documentation fournie avec l'appareil.

3. GENERAL DESCRIPTION

The M-633D is a stereo mixer with digital signal processing functions such as Automatic Resonance Control function (ARC), Feedback Suppressor function (FBS), Automatic Clipguard function (ACG), and Automatic Mute function (AUTO MUTE).

It can be mounted in an EIA component rack (1U size*).

* 1U size = 44.5 mm (standard size)

4. FEATURES

- A stereo mixer equipped with 12 input channels (6 monaural inputs and 3 stereo inputs), and 6 output channels (2 monaural outputs, 1 stereo output, and 1 stereo recording output).
- Assignable each input signal to 3 output channels individually (MONO OUT 1, MONO OUT 2, and STEREO OUT).
- Sound reproduction owing to automatic clarity control (ARC function).
- Automatic feedback suppressor (FBS function).
- Automatic input sensitivity control when an excessive input signal is applied to the monaural input (ACG function).
- Stereo input muted automatically by detecting the monaural input signal (Automatic Mute function).
- Input sensitivity switchable to either -10 dB or -46 dB for the monaural inputs.
- The monaural inputs capable of supplying phantom power (+24 V, 10 mA).
- Assignment switch cover for protecting the assigned setting positions of each input usable as a signal name writing plate.
- Easy function settings using the front and rear panel controls.

5. HANDLING PRECAUTIONS

- The supplied power supply cord is designed for exclusive use with this unit. Never use it with other equipment.
- Install the unit in locations where the temperature is between 0 and 40 °C (32 and 104 °F) and the moisture is less than 90% (no dew condensation must be formed).
- The M-633D is a precision audio component. To prevent failure, avoid locations where the unit may be exposed to strong shocks or vibrations.
- To clean, be sure to first switch off the unit's power, then wipe with a dry cloth. When the unit gets very dirty, use a cloth damped in a neutral cleanser. Never use benzene, thinner, alcohol, or chemically-treated cleaning cloth because such volatile liquids could deform or discolor the unit.

6. NOMENCLATURE AND FUNCTIONS

[Front]

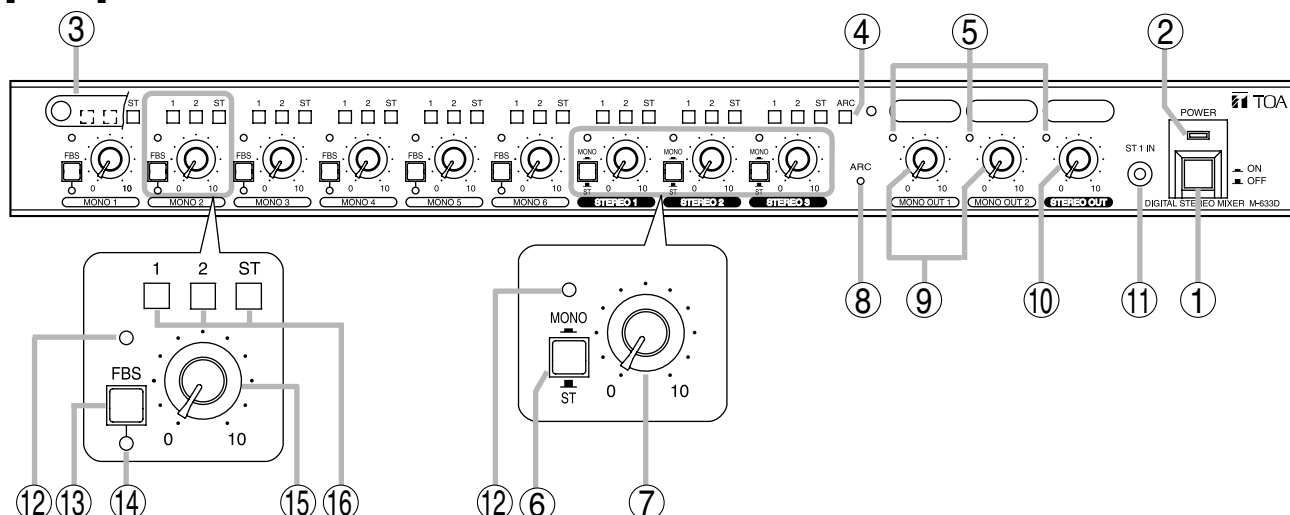

1. Power switch

Press this switch to turn on the power. To turn off the power, press this switch again.

2. Power indicator

Lights green when the power is switched on.

3. Assignment switch cover

A cover for protecting the setting positions of the Assignment switches (16) and ARC switch (4). It can be used as a writing plate.

4. ARC switch

Press this switch to enable the Automatic Resonance Control function (ARC). Hold down this switch for 3 seconds to start the ARC measurement. Release the switch when the ARC operation indicator (8) begins to flash. (See p. 13.) Use a fine-tipped screwdriver to press in the switch.

5. Output level indicators

Light green when the output sound level is appropriate.
Light red when the output signal reaches 6 dB below clipping level.
Light orange when the ARC switch is pressed if the ARC filter has been previously set.

6. Summing output keys

Output the stereo input signals of each channel to the stereo "L" and "R" outputs (17) in stereo mode when not pressed and in monaural mode (summing output) when pressed. (See p. 10.)

7. Stereo input level control knobs

Adjust the stereo input levels.

8. ARC operation indicator

Lights green when the ARC function is operating.

9. Monaural output level control knobs

Adjust the monaural output levels.

10. Stereo output level control knob

Adjusts the stereo output level.

11. Front-mounted stereo input jack

-10 dB*, 10 kΩ, unbalanced type. Connect a stereo mini plug to this jack. It is internally connected in parallel to the STEREO IN 1 (24) on the rear panel. Adjust the input level with the STEREO 1 input level control knob (7).
* 0 dB = 1 V

12. Input level indicators

Light green when the output sound level is appropriate.
Light red when the internal signal reaches 6 dB below clipping level.

13. FBS keys

Press this switch to enable the Feedback Suppression function (FBS). Holding down the key for 1 second switches between on and off states of the FBS function.

14. FBS operation indicators

Light green when the FBS function is operating.

15. Monaural input level control knobs

Adjust the monaural input levels.

16. Assignment switches

Used to select the output destination to which the post-fader input signals of each input channel are routed. (See p. 9.) Press in an individual switch to set the corresponding output destination as follows. To release, press it in again.
1: MONO 1 output, 2: MONO 2 output, ST: STEREO output. Use a fine-tipped screwdriver to press in the switch.

[Rear]

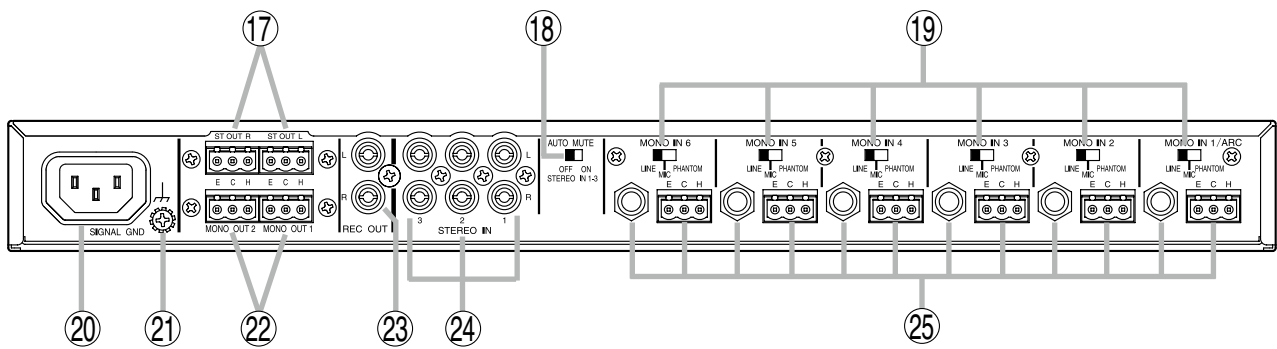

17. Stereo output terminals

0 dB*, 1 k Ω , electronically balanced type.
Use the supplied removable terminal plug for connection.

18. Auto mute switch

Used to turn on and off the Automatic Mute function (AUTO MUTE).

19. Input sensitivity selector switches

Used to select the input sensitivity and phantom power ON/OFF.

Note

Set to "PHANTOM" only when connecting a microphone which requires phantom power (+24 V, 10 mA) to the corresponding input terminal. Connecting an equipment other than this type of microphone to the input terminal set to PHANTOM may cause the unit to malfunction or may generate hum noise.

20. AC inlet

Connect this inlet to the AC wall outlet using the supplied power cord.

21. Functional ground terminal

Hum noise may be generated when external equipment is connected to the unit. Connecting this terminal to the functional ground terminal of the external equipment may reduce the hum noise.

Note: This ground is not for protective ground.

22. Monaural output terminals

0 dB*, 1 k Ω , electronically balanced type.
Use the supplied removable terminal plug for connection.

23. Recording output terminal

-10 dB*, 1 k Ω , unbalanced type.
Use an RCA plug for connection.

24. Stereo input terminals

-10 dB*, 10 k Ω , unbalanced type.
Use an RCA plug for connection.
STEREO IN1 is internally connected in parallel to the front-mounted stereo input jack (11).

25. Monaural input terminals

Input level can be selected by the input level selector switch (19) position as follows.

LINE: -10 dB*/2.4 k Ω

MIC: -46 dB*/2.4 k Ω

PHANTOM: -46 dB*/2.4 k Ω

Removable terminal blocks and phone jacks are provided. Both terminals are electronically balanced type and internally connected in parallel.

* 0 dB = 1 V

7. ASSIGNMENT SETTINGS

It is possible to assign each input to 3 output channels individually (MONO 1, MONO 2, and STEREO).

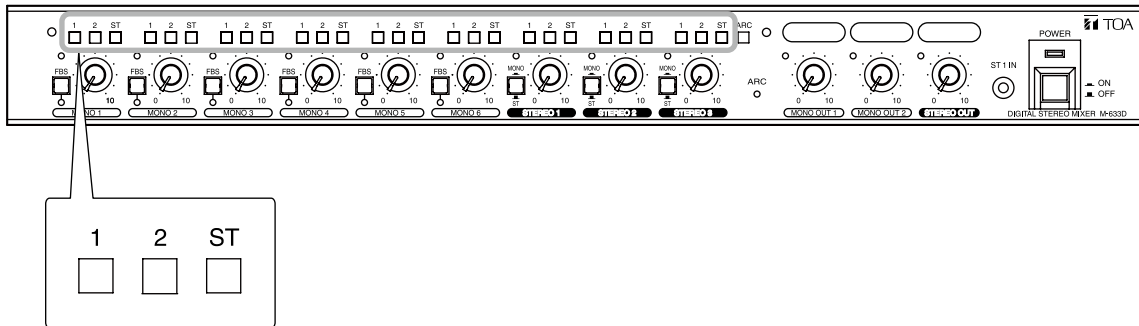

Pressing the Assignment switch "1" routes the input signal to the MONO OUT 1 output, switch "2" to the MONO OUT 2 output, and switch "ST" to the STEREO OUT output. Input signals assigned to the same output destination are mixed.

[Assignment setting example]

The figures below show an example of assignment settings of the inputs.

Input	Assignment switch
MONO 1	1, 2
MONO 2	2, ST
MONO 3	1

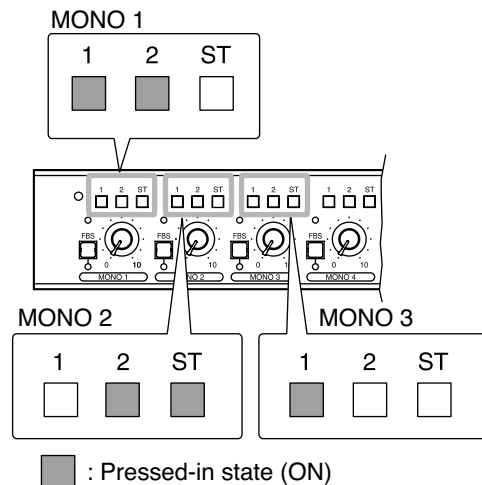

The figure below shows a signal flow.

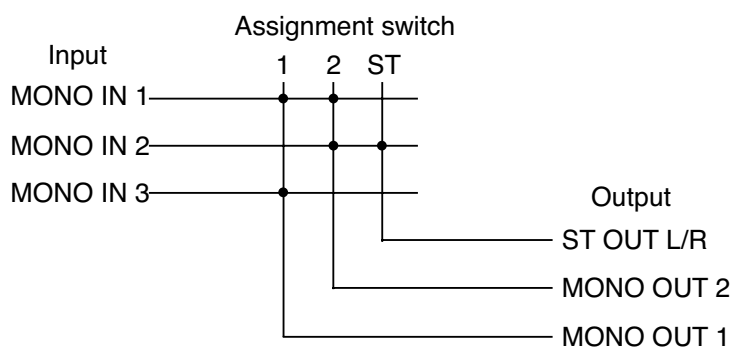

Mixed signals of the MONO IN 1 and MONO IN 3 are output from the MONO OUT 1, those of the MONO IN 1 and MONO IN 2 from the MONO OUT 2, and the MONO IN 2 signal from the ST OUT L/R.

8. USING THE SUMMING OUTPUT KEYS

It is possible to output the stereo input signals applied to the STEREO 1 – 3 to the stereo "L" and "R" outputs either in stereo mode or monaural mode.

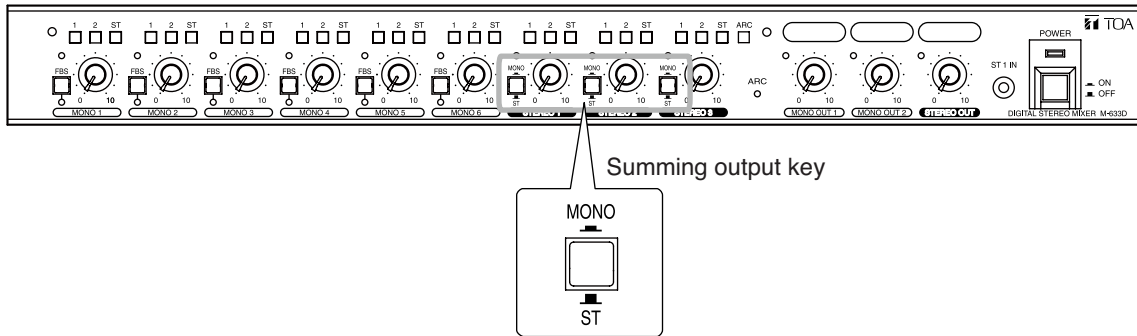

[When the summing output key is pressed in (MONO position)]

Signals applied to each of the input "L" and "R" channels are mixed and output to the stereo "L" and "R" outputs.

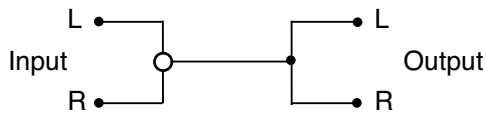

[When the summing output key is not pressed in (ST position)]

The "L" channel's input signal is output to the stereo "L" channel output, and the "R" channel's input signal to the stereo "R" channel output.

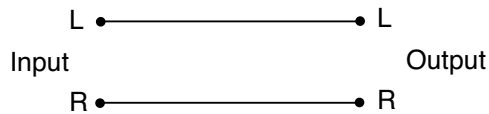

9. SETTING THE ARC FUNCTION

9.1. What is the Automatic Resonance Control (ARC) Function?

It is a function that automatically creates a sound field compensation filter (ARC filter) to improve sound clarity by measuring the inherent acoustic characteristics in architectural space.

9.2. Outline of the ARC Function Settings

The ARC function automatically creates an ARC filter, thereby reproducing highly clear output sound.

9.2.1. Enabling the ARC function (See p. 13 for details.)

Note

Before operating the ARC function, check that sound is actually output from the speakers after installation and connection completion.

Select with the Assignment switches the output channel to which the ARC filter is to be set, hold down the ARC switch for 3 seconds, then release it when the ARC operation indicator begins to flash.

The ARC measurement starts.

The ARC filter is set when the measurement has finished, enabling the ARC function. (The ARC operation indicator lights.)

Note: To stop measurement partway, press the ARC switch again.

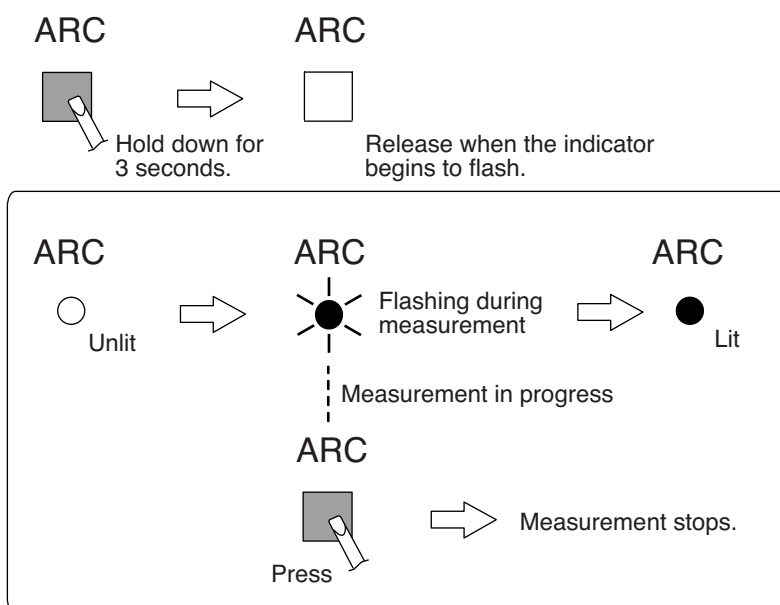

9.2.2. Disabling the ARC function (See p. 20 for details.)

Holding down the ARC switch for 8 seconds or more with all the 3 assignment switches of the MONO 1 in OFF mode (unpressed state) causes the ARC operation indicator to flash. Then it goes off, disabling the ARC function.

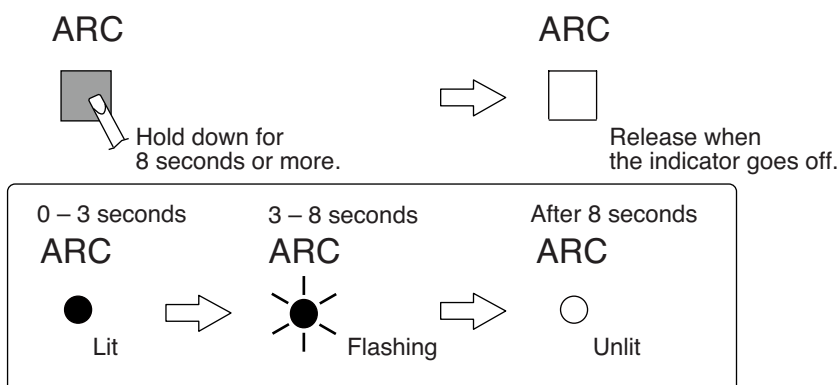

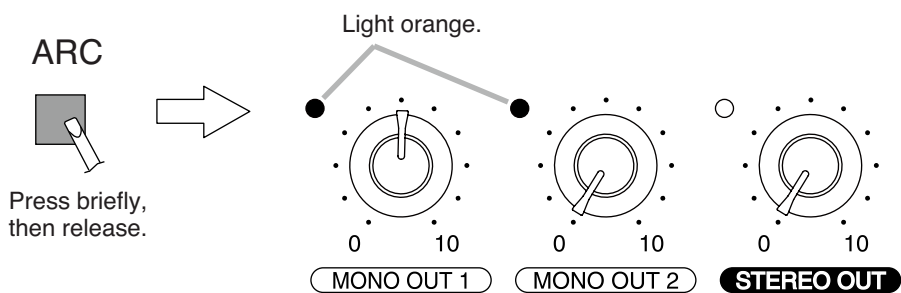

9.2.3. How to confirm the ARC enabled channel

The output level indicator of the ARC enabled (ARC filter preset) output channel lights orange when the ARC switch is pressed.



An example that the ARC filter is set to the MONO OUT 1 and MONO OUT 2 channels.

9.2.4. ARC operation indicator status

ARC measurement in progress	ARC filter ON	ARC filter OFF
 Flashing	 Lit	 Unlit

9.2.5. ARC measurement procedure

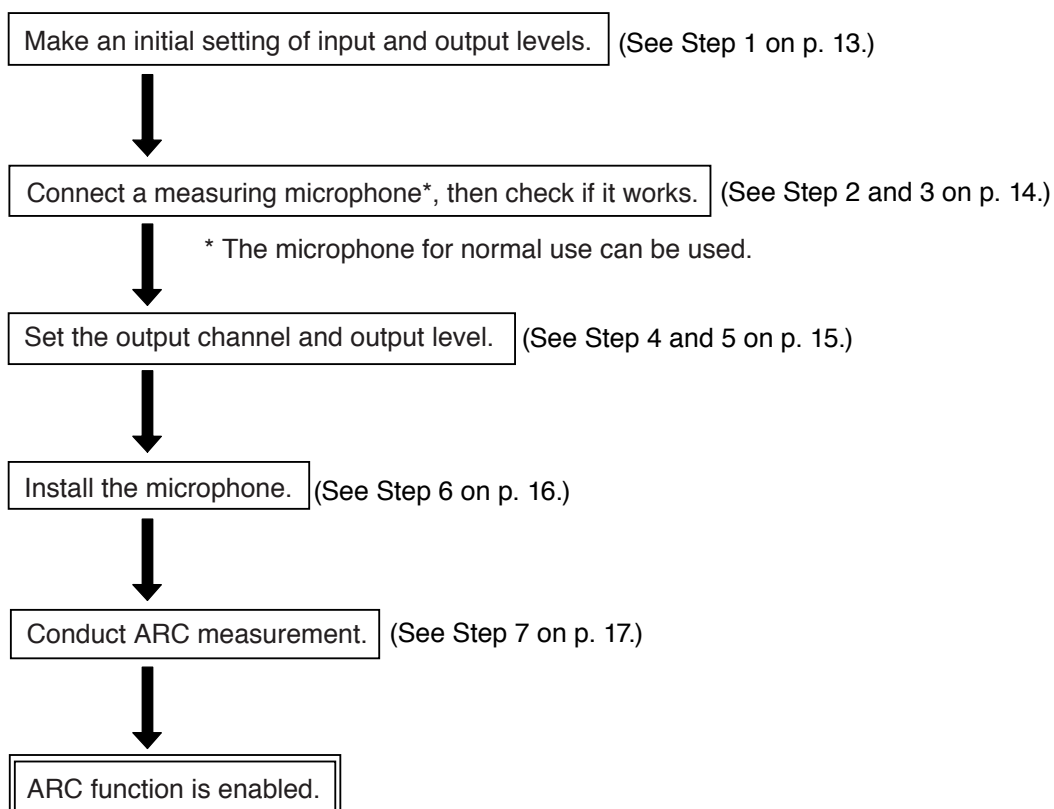

9.3. Enabling the ARC Function

Notes

- The ARC filter is created on the output channel selected with the Assignment switches at the ARC measurement.
- The ARC filter previously set on the output channel will be updated by the newly created ARC filter after the ARC measurement.
- To initialize the ARC filter, disable the ARC function. (See p. 20.)
The ARC filters for all the output channels are initialized. They cannot be initialized individually.
- Use a fine-tipped screwdriver to press in the Assignment and ARC switches.

Step 1. Make an initial setting of the input and output levels.

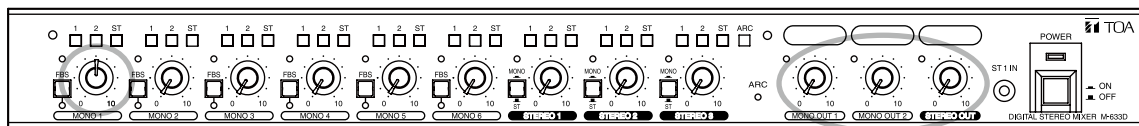

1-2

1-1

1-1. Turn all the output level control knobs to the "0" position.

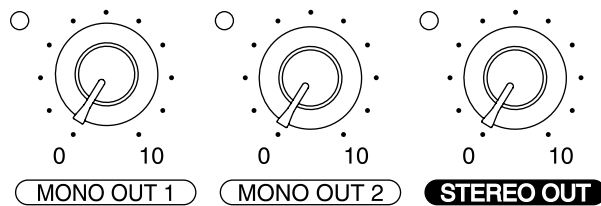

1-2. Turn the MONO 1 input level control knob to the 12 o'clock position.

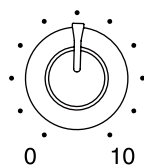

1-3. Fully turn down the output volume of the connected amplifier.

Step 2. Connect a measuring microphone.

The microphone for normal use can be used.

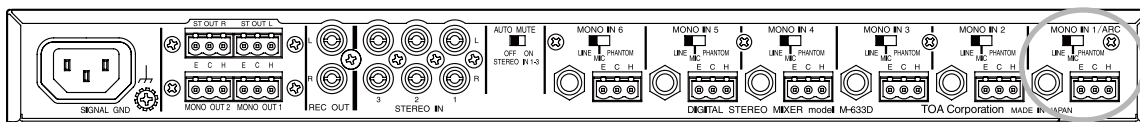

2-1. Connect the microphone to the phone jack or removable terminal block of MONO IN 1/ARC on the rear panel.

2-2. Set the input sensitivity selector switch to the appropriate position depending on the microphone to be connected.
 Dynamic microphone: MIC
 Phantom powered condenser microphone: PHANTOM
 Wireless tuner output (Line level): LINE

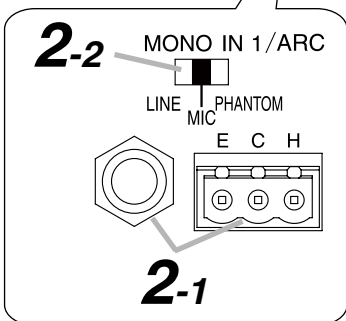

Step 3. Check to see if the microphone works correctly.

3-1. Speak into the microphone.
 Confirm that the MONO 1's input level indicator lights green.

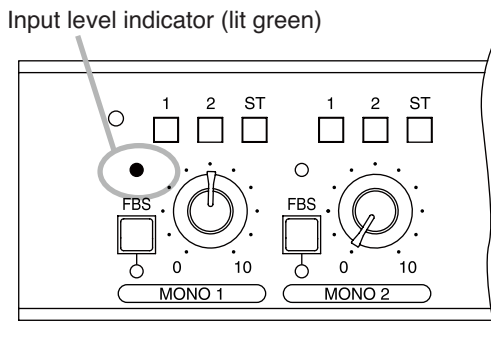

Notes

- Hold the microphone about 7 cm (3") from the mouth. Speak at a normal voice level.
- Sound is not output from the speakers at this stage as the unit's output level control knobs are turned fully counterclockwise.

3-2. Check to see the following settings if the input level indicator does not light green.

When the indicator does not light

Input signal is too small.

- Check that the microphone switch is turned ON.
- Check that the rear-mounted input sensitivity selector switch is placed in the correct position for the microphone.

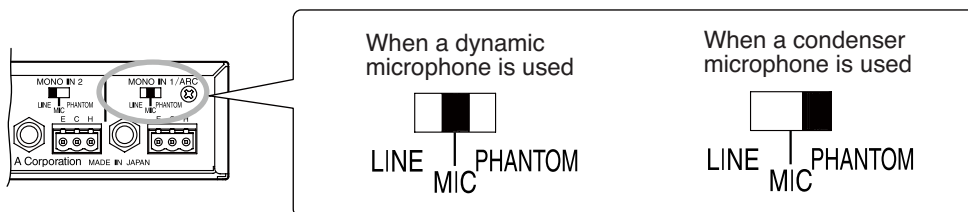

When the indicator lights red

Input signal is too big.

- Check the position of the input sensitivity selector switch on the unit's rear panel. Try to set the switch to "LINE."

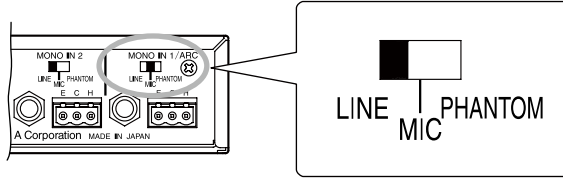

Step 4. Select the output channel.

Press in the MONO 1's assignment switch corresponding to the output channel to which the ARC filter is set.

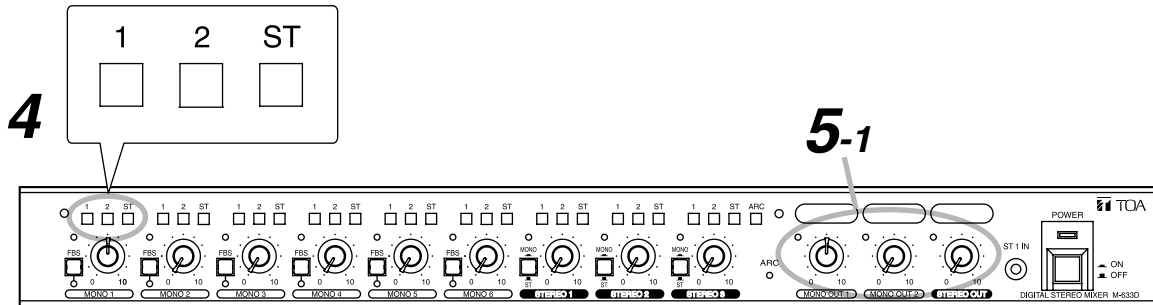

Step 5. Set the output volume level.

- 5-1.** Turn the output level control knob corresponding to the assignment switch selected in Step 4 to the 12 o'clock position. (Setting example of MONO OUT 1)

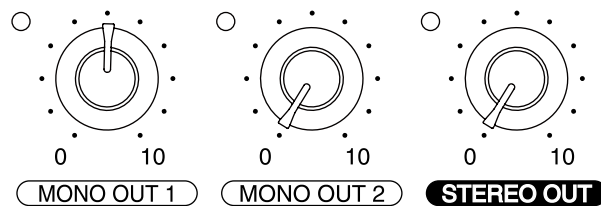

- 5-2.** Adjust the power amplifier's volume level.

Speaking into the connected measuring microphone, adjust the volume to the level normally used with the volume control knob of the amplifier connected to the unit.

Step 6. Install the measuring microphone.

It is recommended to install the microphone as shown below as a guide.

[Microphone setting example]

Height of the microphone: At the listening position

Angle of the microphone: 45 ° up

Location of the microphone: About the center of the room
(See the figure below.)

Direction of the microphone: Point to the speaker. (See the figure below.)

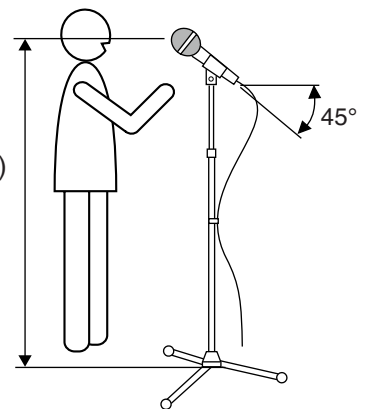

[Microphone setting example]

School room: Point to a platform.

Gymnasium and multipurpose auditorium: Point to the center of the stage.

Conference room: Point to the chairperson.

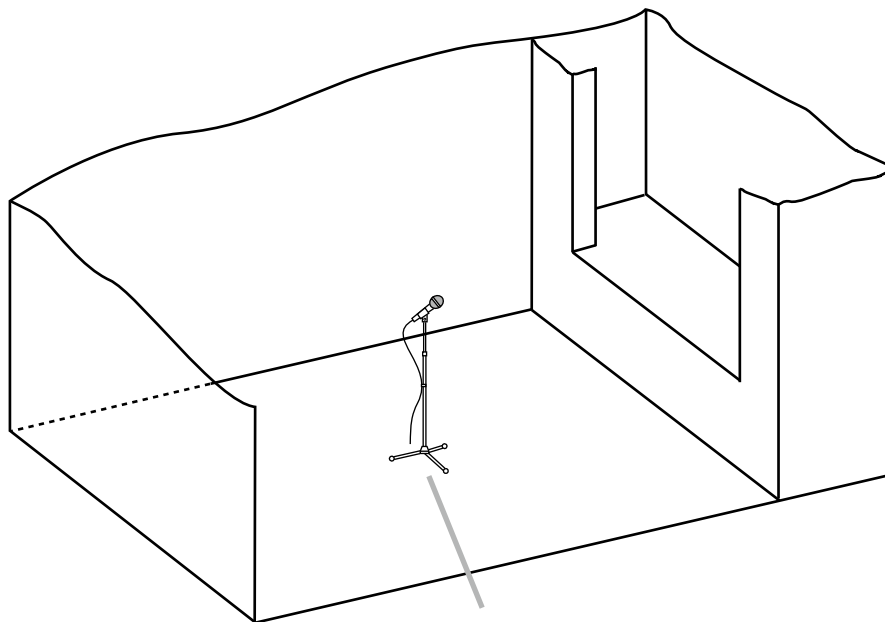

Location of the microphone: About the center of the room

Step 7. Conduct ARC measurement.

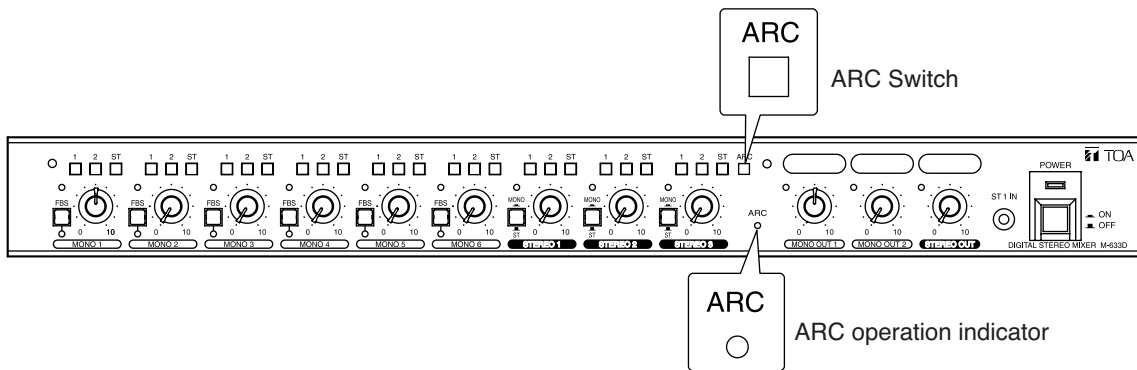

Hold down the ARC switch for 3 seconds.
The ARC operation indicator begins to flash and the measurement starts.

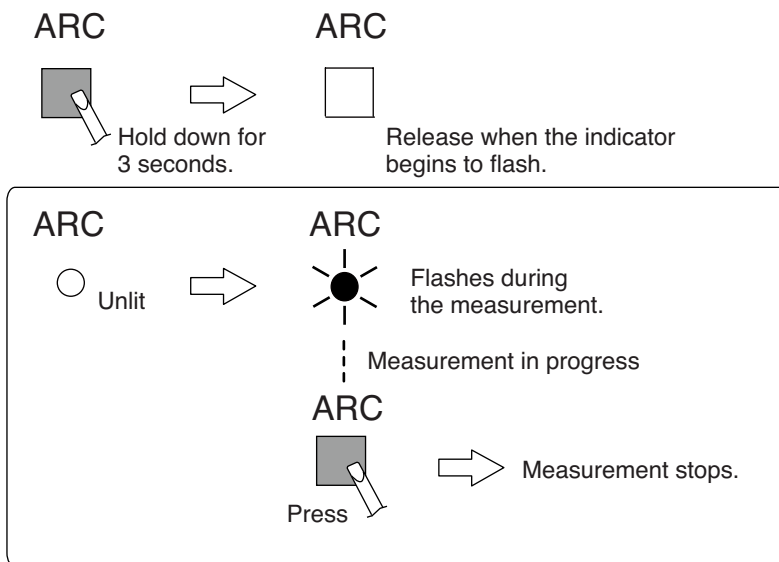



Notes

- To stop measurement partway, press the ARC switch.
- Never operate the switches and knobs of the unit and the external equipment during the ARC measurement.

[ARC measurement operation]

A 3-stage operation shown on the next page is performed during the ARC measurement. Different tones sound in each operation stage. The ARC operation indicator flashes slowly during normal measurement, but it begins to flash rapidly when a failure occurs.

ARC operation indicator status

Measurement progresses normally	A failure occurs
<p>ARC</p>  <p>Flashing slowly</p>	<p>ARC</p>  <p>Flashing rapidly</p>

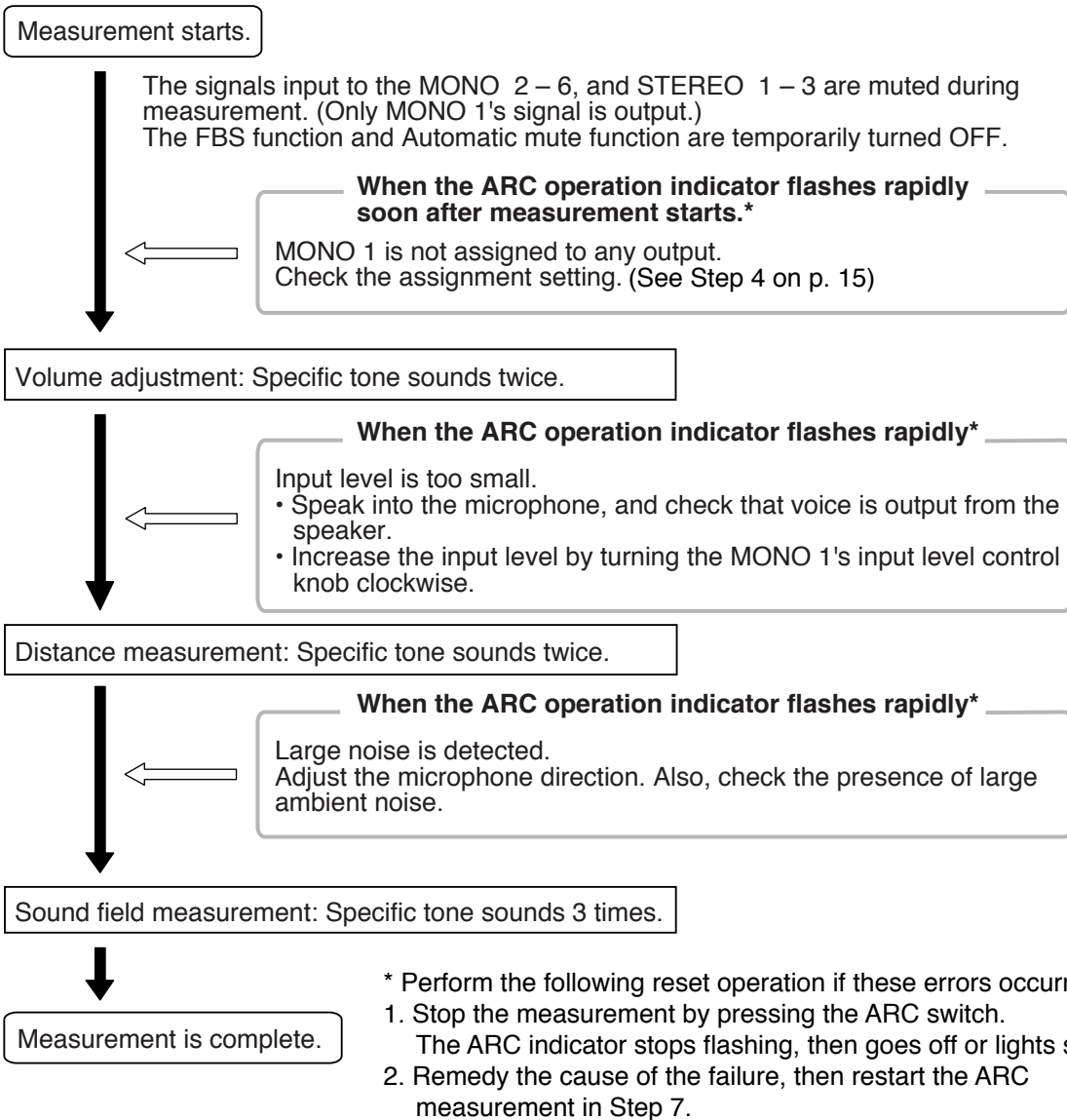

Measurement is complete, and the ARC filter is set.

The output level indicator of the ARC enabled output channel flashes orange for 1 second. In this case, the ARC operation indicator changes from flashing to steady on (green). The ARC filter data is automatically saved, and remains effective even after power is cycled.

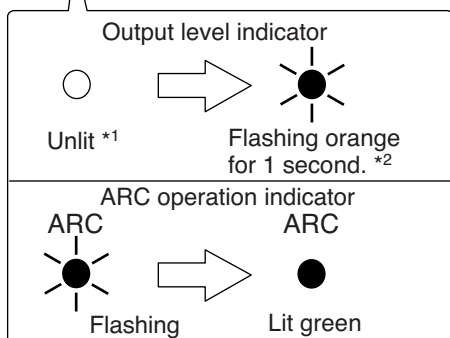
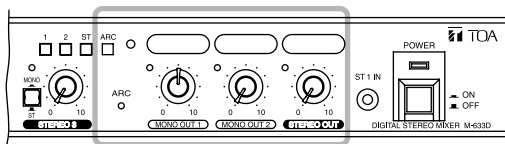

*1 The indicator may light green depending on the input level of the microphone.

*2 The output level indicator of the channel where the ARC filter has already been set flashes orange even when this channel was not assigned at the time of ARC measurement.

Note

After measurement completion, move the microphone to your desired location.

9.4. Making Fine Acoustic Adjustment

When finer acoustic adjustment is required, different ARC filters can be set for individual output channels.

[Setting example in a gymnasium where the unit's output channels are assigned as follows]

Set different ARC filters to the MONO OUT 1 channel and STEREO OUT channel.

Cable wiring example

- MONO OUT 1 channel: Ceiling speakers
- MONO OUT 2 channel: No connection
- STEREO OUT channel: Stereo speakers installed at both sides of the stage

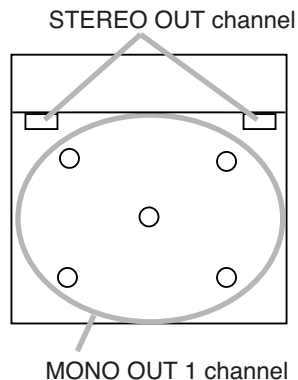

Step 1. Set the ARC filter only to the MONO OUT 1 channel (ceiling speakers).

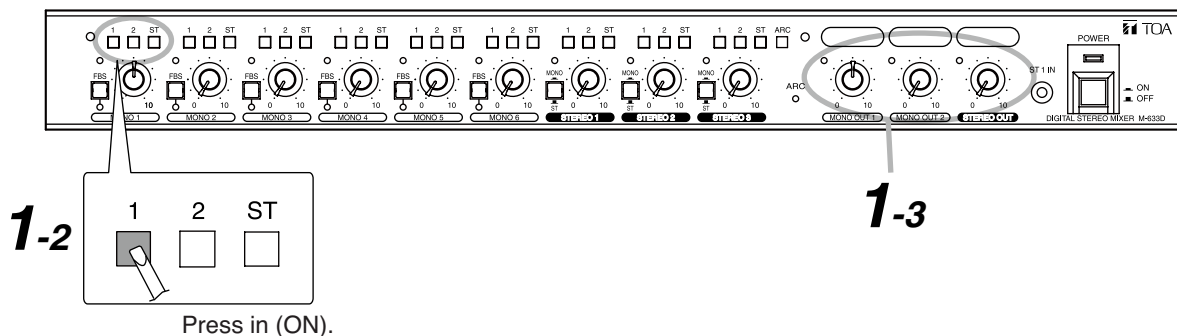

1-1. Turn the MONO 1's input level control knob to the 12 o'clock position.

1-2. Press in only the MONO 1's Assignment switch "1" to turn it ON.

- 1: ON
- 2: OFF
- ST: OFF

1-3. Turn the MONO 1's output level control knob to the 12 o'clock position.

1-4. Adjust the volume level of the output amplifier connected to the MONO OUT 1.

1-5. Conduct ARC measurement. (See Step 7 on p. 17.)
The ARC filter is assigned to the MONO OUT 1 channel.

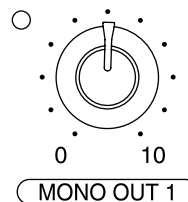

Step 2. Set ARC filter only to the STEREO OUT channel (Stereo speakers installed at both sides of the stage).

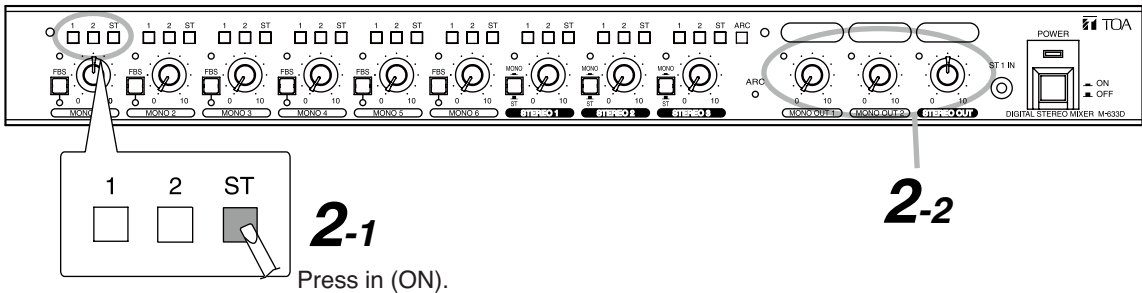

2-1. Press in only the MONO 1's assignment switch "ST" to turn it ON.

- 1: OFF
- 2: OFF
- ST: ON

2-2. Turn the output level control knobs as follows.

- MONO OUT 1: To the "0" position
- STEREO OUT 2: To the 12 o'clock position.



2-3. Adjust the volume level of the output amplifier connected to the STEREO OUT.

2-4. Conduct ARC measurement. (See Step 7 on p. 17.)
The ARC filter is assigned to the STEREO OUT channel.



Different ARC filter settings are complete to each output of the MONO OUT 1 channel and STEREO OUT channel.

The ARC filter data is automatically saved, and remains effective even after power is cycled.

9.5. Disabling the ARC Function

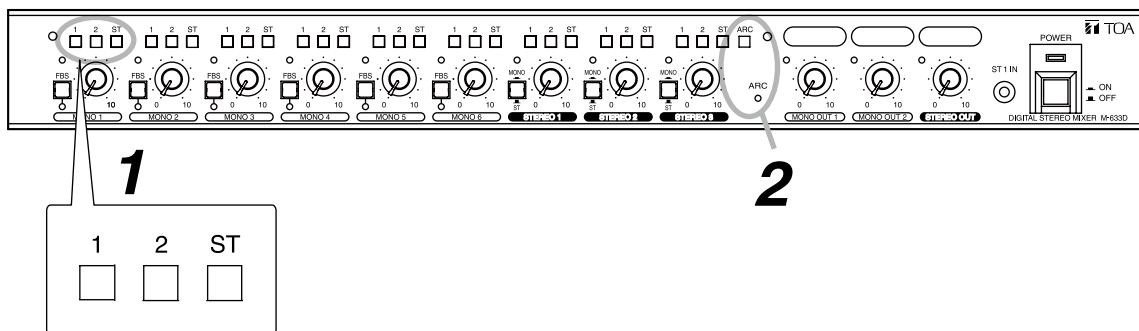

Step 1. Place the MONO 1's all 3 assignment switches in unpressed state.

Step 2. Hold down the ARC switch for 8 seconds.

The ARC operation indicator flashes rapidly after 3 seconds. Continue to hold it down for 5 seconds. The ARC operation indicator goes off, disabling the ARC function.

ARC



Hold down for 8 seconds.

ARC



Release when it goes off.

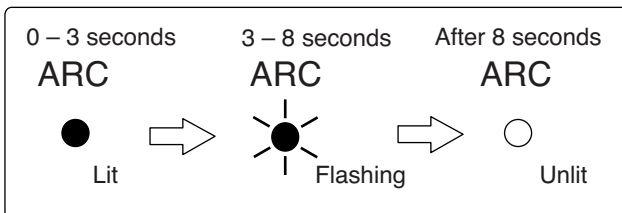

10. SETTING THE FBS FUNCTION

10.1. What is the Feedback Suppressor Function (FBS)?

It is a function that the built-in feedback suppressor filter automatically works to suppress acoustic feedback when the feedback occurs.

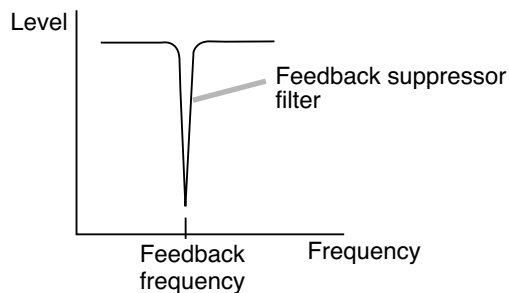

10.2. Setting the FBS Function

If acoustic feedback occurs when the FBS function is enabled, the feedback suppressor filter automatically operates to suppress the feedback.

The FBS function assigned to each of the MONO 1 – 6 channels can operate independently.

10.2.1. Enabling the FBS function

Hold down the FBS key for 1 second or more when the FBS operation indicator remains unlit.

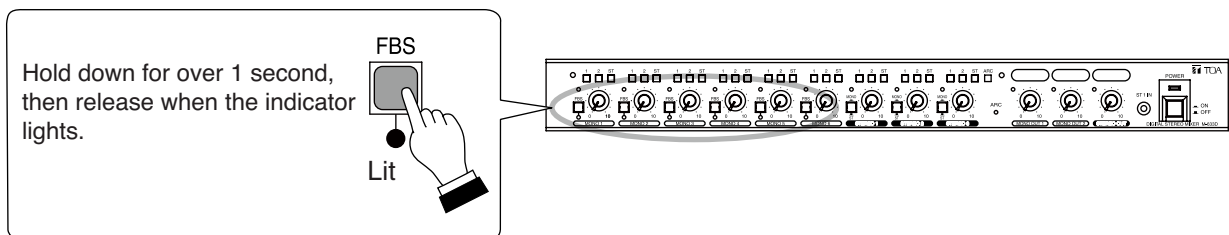

The FBS operation indicator will light, and the FBS function is enabled.

Notes

- Feedback may not be suppressed as the case may be. In this case, decrease the corresponding channel's monaural input level by turning the control knob counterclockwise.
- Feedback suppressor filter settings are not stored. The setting data is initialized when the power is turned off. However, the FBS function enabled or disabled status is stored.

10.2.2. Disabling the FBS function

Disabling the FBS function causes the feedback suppressor filter to be initialized.

Hold down the FBS key for 1 second or more while the FBS operation indicator is lighting.



The indicator goes off, and the FBS function is disabled.

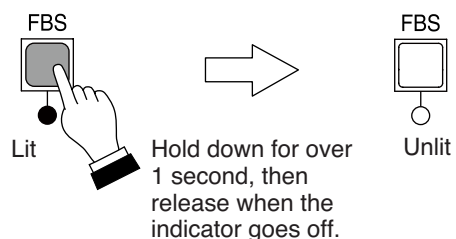

11. SETTING THE AUTOMATIC MUTE FUNCTION

11.1. What is the Automatic Mute Function (AUTO MUTE)?

It is a function that attenuates the signal input to the STEREO 1 through 3 by detecting signals input to the MONO 1 – 6.

AUTO MUTE is also called as Ducker.

This function helps to have paging announcements heard distinctly by attenuating the BGM volume when initiating the announcement during BGM broadcast.

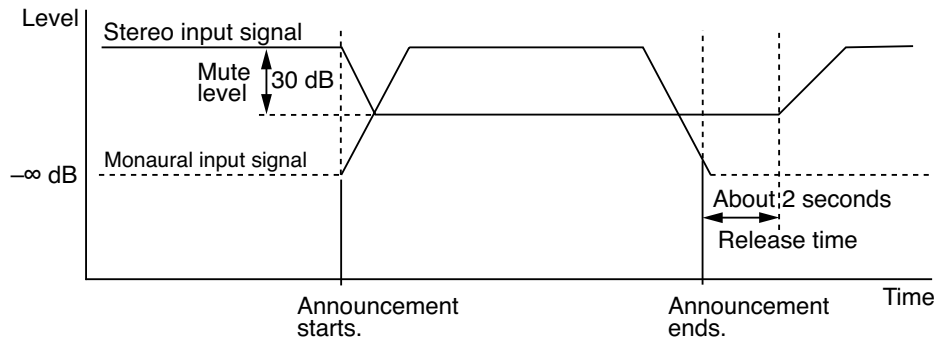

Tip

A release time is the period of time from the announcement end to the stereo signal mute release start.

11.2. Setting the Automatic Mute Function

Use the rear-mounted AUTO MUTE switch to set the Automatic Mute function.

Shifting the AUTO MUTE switch to the ON position turns on the AUTO MUTE function. Shifting it to the OFF position turns off the AUTO MUTE function.

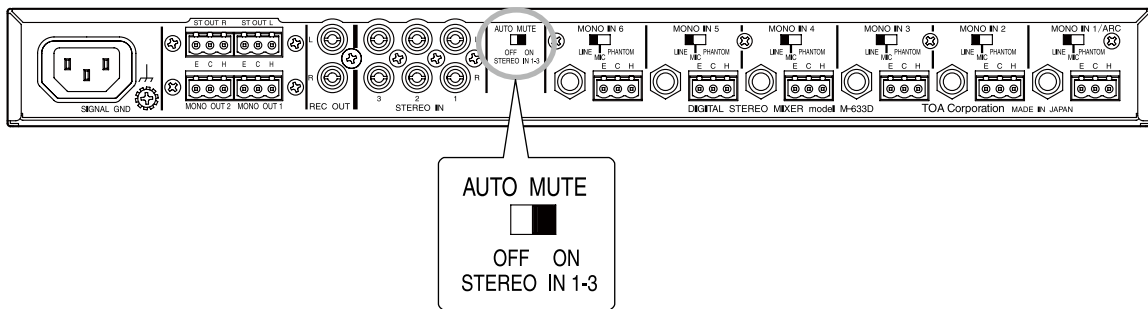

Tip

The input level indicators of the STEREO 1 – 3 light orange while these signals are being attenuated. The attenuation level is 30 dB.

12. AUTOMATIC CLIPGUARD (ACG) FUNCTION

It is a function that automatically control input sensitivity to an appropriate value when the broadcast is distorted in the presence of an excessive input signal.

For example, the ACG function prevents the broadcast from being made with its sound distorted even if a line level signal is erroneously applied to the MONO IN input set to "MIC."

The ACG function operates on each channel with the input sensitivity selector switch placed in "MIC" or "PHANTOM" position.

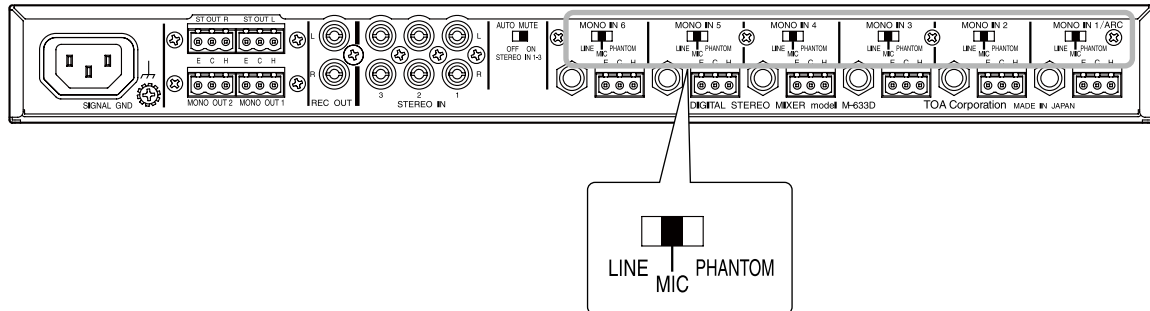

Notes

- If the ACG function works, something is wrong with connection. Make cable connection correctly after an announcement is complete.
- Distorted sound is output from the unit for several seconds in order to detect distortion, however, this is not a failure.

13. RESETTING TO FACTORY DEFAULT SETTINGS

Step 1. Disable the ARC function. (See p. 20.)

Step 2. Disable the FBS function. (See p. 21.)

Step 3. Turns off the Automatic mute function.

Shift the rear-mounted AUTO MUTE switch to the OFF position.

Step 4. Disable the ACG function

Shift all the Input sensitivity selector switches of the rear-mounted MONO IN 1 – 6 to the "LINE" position.

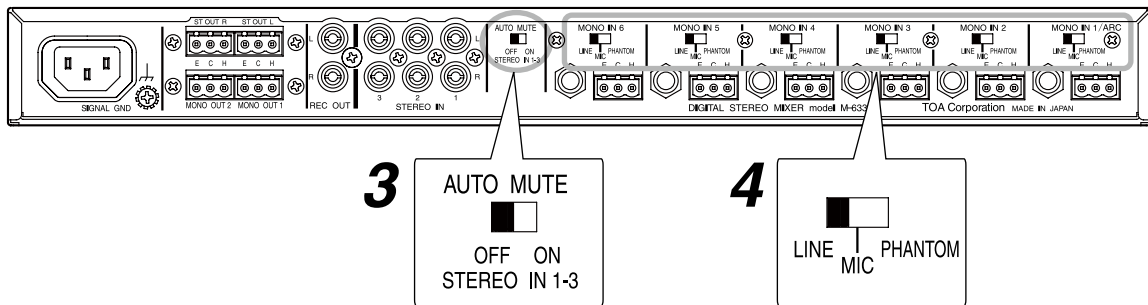

The settings are returned to the factory default settings.

14. INSTALLATION

14.1. Mounting in a Rack

Mount the unit in an equipment rack using the supplied rack mounting screws.

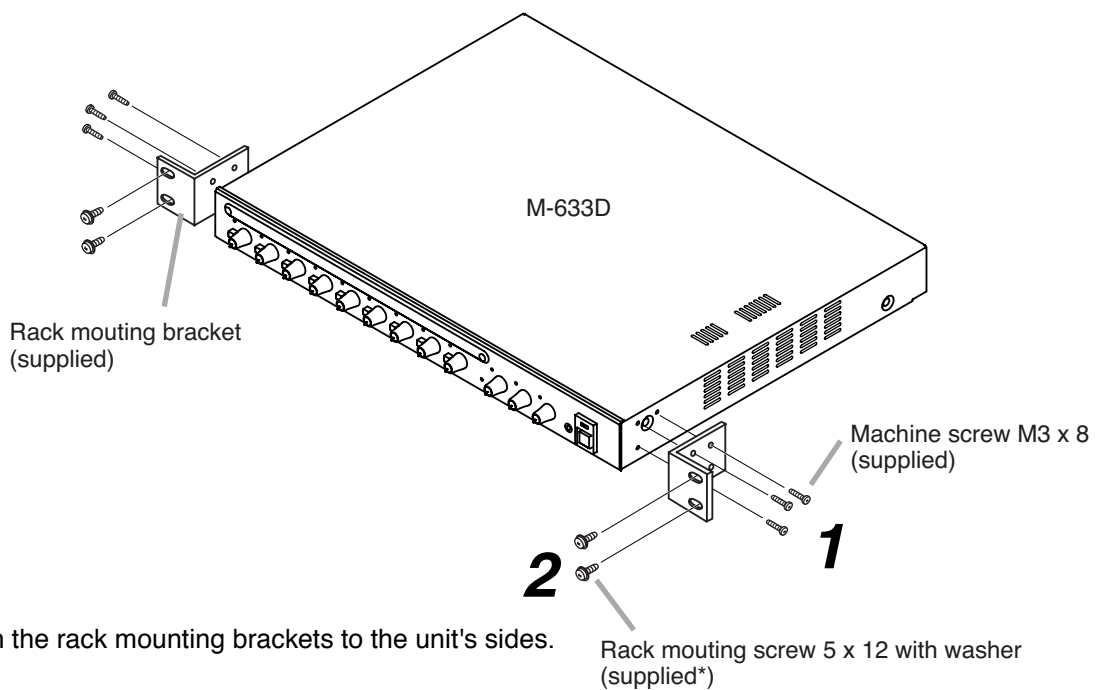

Step 1. Attach the rack mounting brackets to the unit's sides.

Step 2. Mount the unit in a rack.

* Not supplied with the unit of US version (M-633D CU).

CAUTION

When installing the unit in an equipment rack, do not block the ventilation slots on the unit's sides and rear. Doing so may cause heat to build up inside the unit and result in fire.

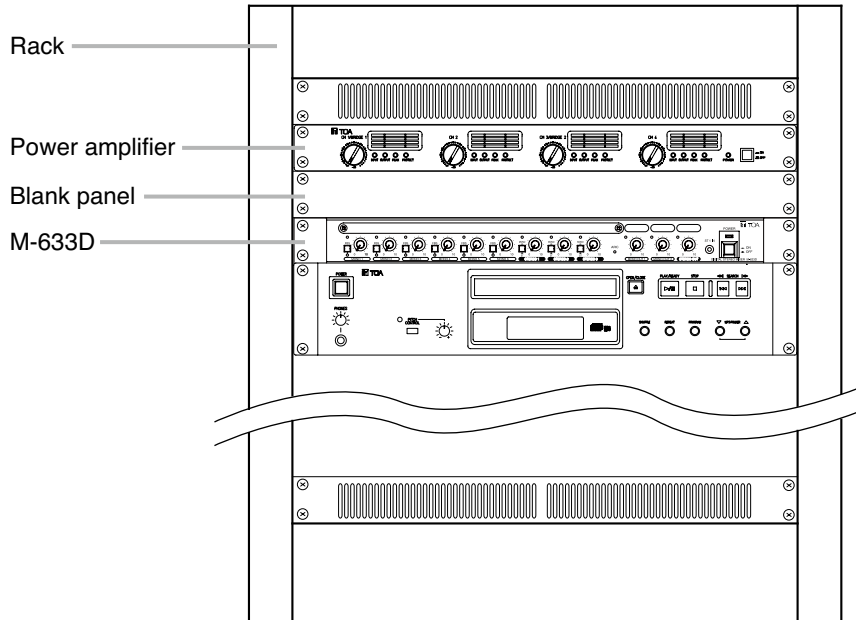

14.2. Mounting on a Desk

When installing the unit on a desk, attach the supplied rubber feet to the unit's bottom surface.

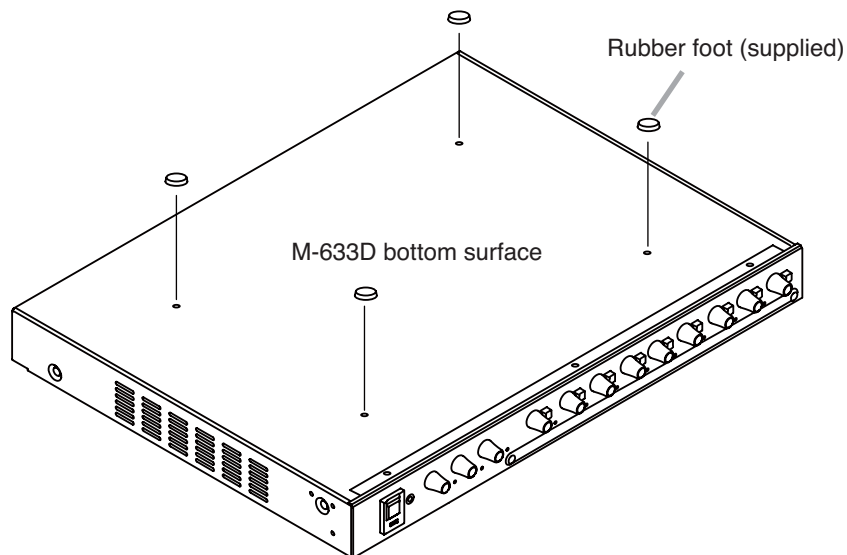

15. CONNECTION

15.1. Connection Example

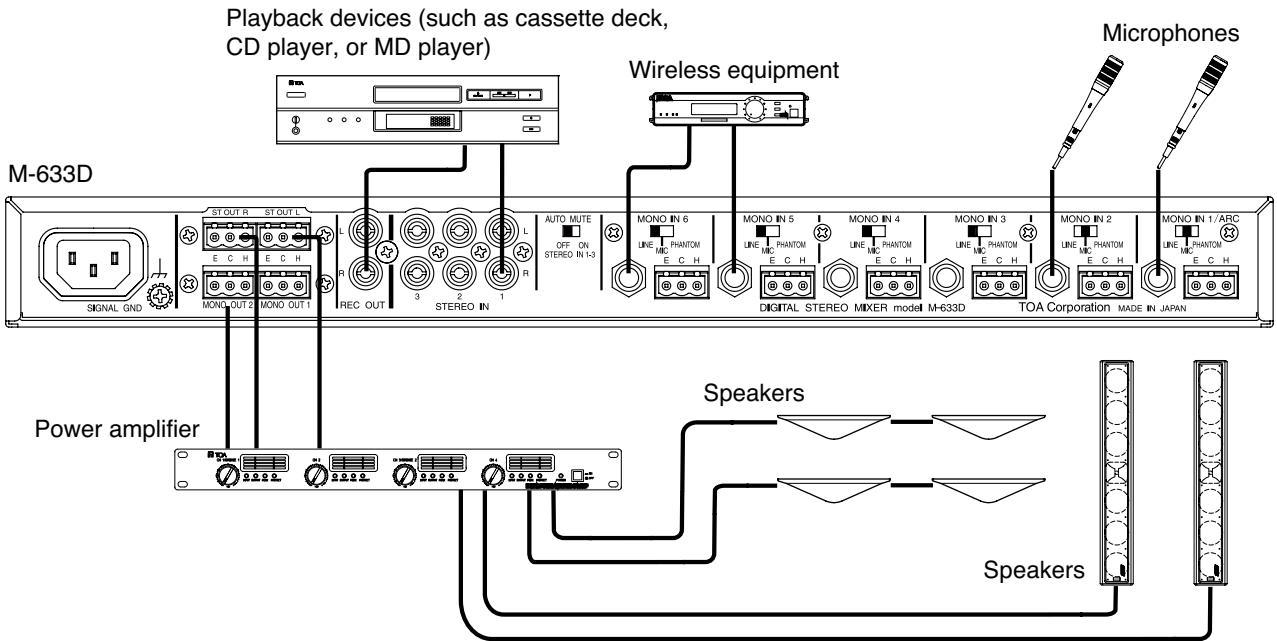

15.2. Phantom Power Supply

- Set the rear-mounted Input level selector switch to "PHANTOM" position only when connecting a microphone which requires phantom power (+24 V, 10 mA) to the corresponding input terminal. Connecting an equipment other than this type of microphone to the input terminal set to PHANTOM may cause the unit to malfunction or may generate hum noise.
- Phantom power is not supplied to the phone jacks (MONO IN 1 – 6).

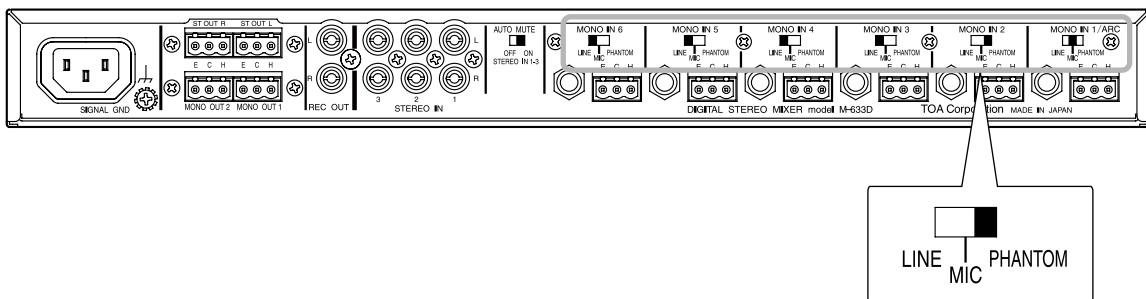

15.3. Removable Terminal Plug Connection

Notes

- Be sure to use shielded cables for audio signal lines.
- Avoid soldering cable conductor, as contact resistance may increase when the cable is tightened and the solder is crushed, possibly resulting in an excessive rise in joint temperatures.

[Cable end treatment]

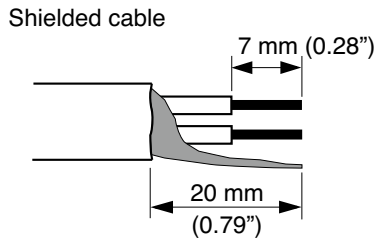

[Connector connections]

Step 1. Loosen the terminal screw, then insert the cable.

Step 2. Retighten the terminal screw. (Pull on the cable to ensure it is securely connected.)

Step 3. Insert the removable terminal plug into the input/output terminal block on the unit's rear panel.

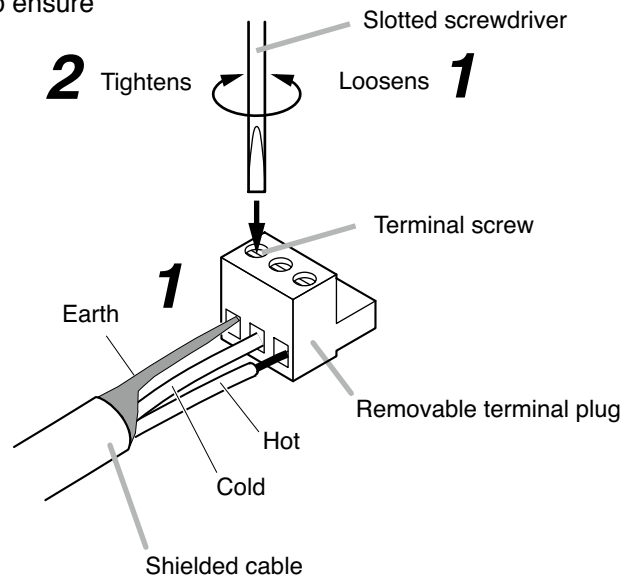

Tip

Recommended slotted screwdriver type: Screwdriver with blade that is 3 mm (0.12") in width

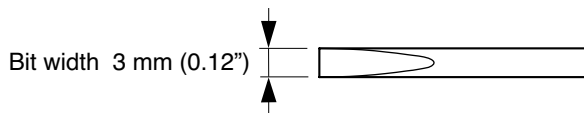

16. BLOCK DIAGRAM

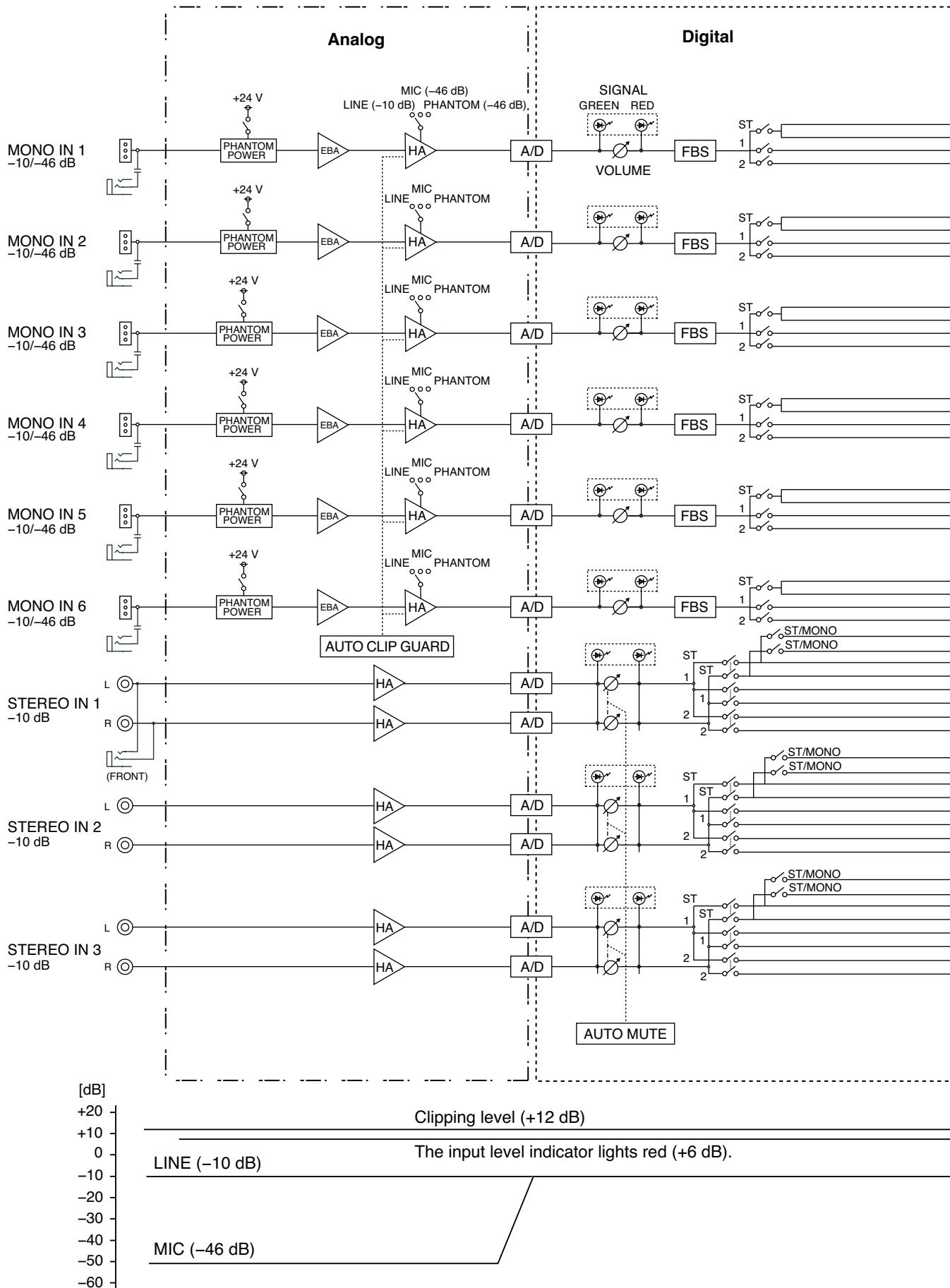

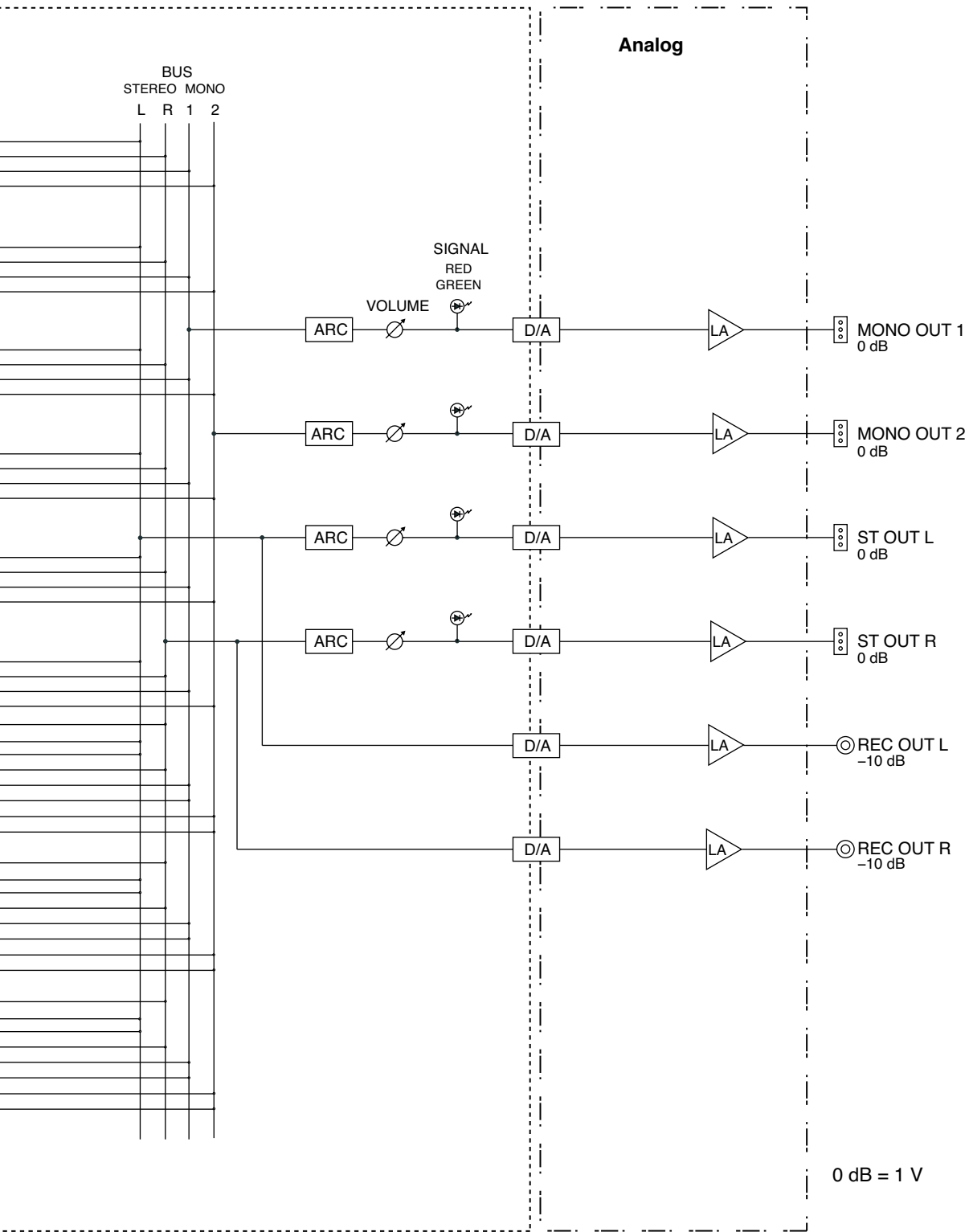

[dB]

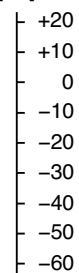

LINE (0 dB)
STEREO (0 dB)
REC OUT (-10 dB)

17. DIMENSIONAL DIAGRAM

Unit : mm (in)

[Rear]

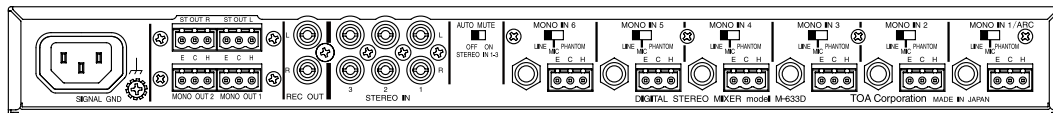

[Front]

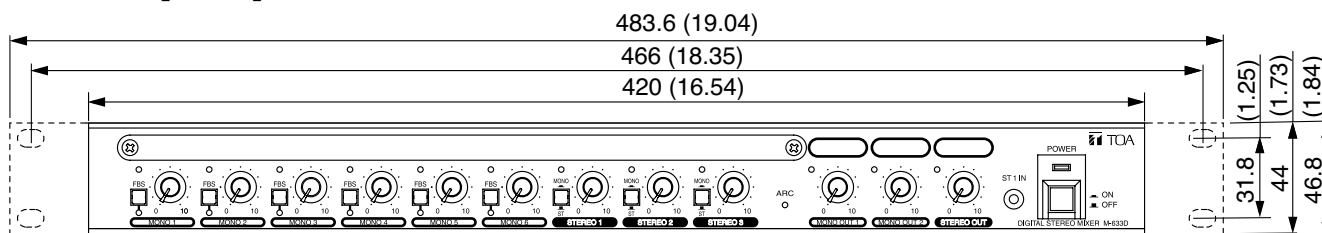

[Side]

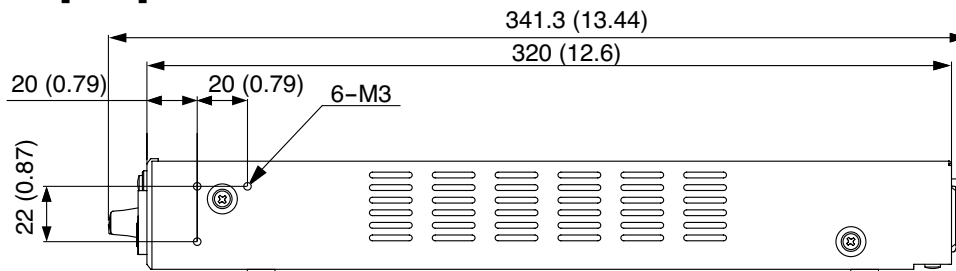

18. SPECIFICATIONS

Model No.	M-633D CU	M-633D CE, CE-GB	M-633D CE-AU, CN	M-633D KR	M-633D TW
Power Source	120 V AC 60 Hz	220 – 240 V AC 50/60 Hz	220 – 240 V AC 50 Hz	220 V AC 60 Hz	100 – 120 V AC 60 Hz
Power Consumption	13 W	14 W	14 W	14 W	13 W
Frequency Response	20 Hz – 20 kHz				
Sampling Frequency	48 kHz				
Dynamic Range	Over 90 dB (IHF–A weighted)				
Distortion	Under 0.03%, 1 kHz, –10 dB* input, 0 dB* output (20 Hz – 20 kHz, BPF)				
Input	<p>6 monaural input channels (MONO IN 1 – 6), selectable independently from 3 types of inputs below for each channel</p> <p>LINE: –10 dB*, 2.4 kΩ, electronically balanced</p> <p>MIC: –46 dB*, 2.4 kΩ, electronically balanced</p> <p>PHANTOM: –46 dB*, 2.4 kΩ, supplies phantom power of +24 V DC, 10 mA, electronically balanced</p> <p>Removable terminal block (3P), phone jack</p> <p>3 stereo inputs (L, R) (STEREO IN 1 – 3) : –10 dB*/10 kΩ, RCA jack (STEREO IN 1 – 3), Stereo mini jack (ST IN 1)</p>				
Output	<p>2 monaural output channels (MONO OUT 1, 2) : 0 dB* (applicable load: over 1 kΩ), electronically balanced, removable terminal block (3P)</p> <p>1 stereo output (L, R) channel (ST OUT L, R) : 0 dB* (applicable load: over 1 kΩ), electronically balanced, removable terminal block (3P)</p> <p>1 stereo recording output (L, R) channel (REC OUT L, R) : –10 dB* (applicable load: over 1 kΩ), RCA jack</p>				
Bus Line	Monaural channel x 2, Stereo channel x 1				
AD Converter	24 bits				
DA Converter	24 bits				
Signal Processing					
Automatic Resonance Control Function (ARC)	<p>3 output channels (each monaural output channel, stereo output L, R), independent settings for each channel, automatic creation of EQ curves (for sound field compensation)</p> <p>ARC measurement start switch x 1, Function ON/OFF check indicator x 1</p>				
Feedback Suppression Function (FBS)	<p>6 channels (each monaural input channel), independent settings for each channel</p> <p>Function ON/OFF switch x 6</p> <p>Function ON/OFF check indicator x 6</p>				
Automatic Clipguard Function (ACG)	6 channels (each monaural input channel), independent operation for each channel				
Automatic Mute Function (AUTO MUTE)	Function ON/OFF switch x 1				
Input Level Indicator	2-color LED indicator: Green (for appropriate level)/red (for peak level)				
Output Level Indicator	2-color LED indicator: Green (for appropriate level)/red (for peak level)				
Operating Temperature	0 to 40 °C (32 to 104 °F)				
Operating Humidity	Under 90% RH (no condensation)				
Finish	Panel: Aluminum, black, hair-line Case: Precoated steel sheet, black, 30% gloss				
Dimensions	420 (w) x 44 (h) x 341.3 (d) mm (16.54" x 1.73" x 13.44")				
Weight	4.0 kg (8.82 lb)				

* 0 dB = 1 V

Note: The design and specifications are subject to change without notice for improvement.

• **Accessories**

Power cord (2 m or 6.56 ft)	1	Rack mounting bracket	2
Removable terminal plug (3P)	10	Rack mounting screw 5 x 12*	4
Rubber foot	4	Machine screw M3 x 8	6

* Not supplied with the unit of US version (M-633D CU)

FCC REQUIREMENTS

Note

This equipment has been tested and found to comply with the limits for a Class A digital device, pursuant to Part 15 of the FCC Rules. These limits are designed to provide reasonable protection against harmful interference when the equipment is operated in a commercial environment. This equipment generates, uses, and can radiate radio frequency energy and, if not installed and used in accordance with the instruction manual, may cause harmful interference to radio communications.

Operation of this equipment in a residential area is likely to cause harmful interference in which case the user will be required to correct the interference at his own expense.

Modifications

Any modifications made to this device that are not approved by TOA Corporation may void the authority granted to the user by the FCC to operate this equipment.

This Class A digital apparatus complies with Canadian ICES-003.
Cet appareil numérique de la classe A est conforme à la norme NMB-003 du Canada.

Warning

This equipment is compliant with Class A of CISPR 32. In a residential environment this equipment may cause radio interference.

Traceability Information for Europe

Manufacturer:
TOA Corporation
7-2-1, Minatojima-Nakamachi, Chuo-ku, Kobe, Hyogo,
Japan

Authorized representative:
TOA Electronics Europe GmbH
Suederstrasse 282, 20537 Hamburg,
Germany

URL: <http://www.toa.jp/>